

POOLDOSE SINGLE

INSTRUCTIONS MANUAL **EN**

HANDBUCH **DE**

MANUAL DE INSTRUCCIONES **ES**

MANUEL D'INSTRUCTIONS **FR**

MANUALE D'INSTALLAZIONE **IT**



WARNING!

Before carrying out ANY work inside control panel of the PoolDose device, make sure you disconnect it from the power supply.

Failure to comply with the instructions contained in this manual could cause injury to people and/or damage to the appliance and the system.

1. PACKAGE CONTENT

 A: Tapping saddle for securing PSS3 onto 2" hose (φ=50 mm)	 B: Foot filter (PP riser)	 C: Mounting bracket kit (φ=6 mm screws)	 D: FPM Lip valve (3/8" GAS)	 E: PSS3 probe-holder (1/2" GAS)
 F: pH probe	 G: Redox probe	 H: pH 7 Buffer solution	 I: pH 4 Buffer solution	 J: 465 mV Calibration solution
 K: Water	 L: 4x6 (IDxOD mm) PVC tube (4m)	 M: 4x6 (IDxOD mm) PE tube (5m)	 N: Reducer for injection valve (1/2" M to 3/8" F)	 O: Temperature Probe (1/2" M)

Item*	A	B	C	D	E	F	G	H	I	J	K	L	M	N	O
PoolDose pH	2(*1)	1	1	1	1	1	-	1	1	-	1	1	1	1	1(*2)
PoolDose ORP	2(*1)	1	1	1	1	-	1	-	-	1	1	1	1	1	1(*2)

* The values from the table represents the number of items inside the package.

(*1 Three pieces in WiFi model only)

(*2 One piece in WiFi model only)

PoolDose | pH · ORP

WARNING!

These products are **DANGEROUS** and require special precautions during use, handling and storage.

- **NEVER mix chemical products.**
- NEVER allow children or people who have not read this manual to use or tamper with PoolDose or any of its peripheral components (including chemical products).

pH chemical products:

- **ABSOLUTELY** not recommended => pure sulphuric acid
- Recommended for lowering pH => negative pH (with a sulphuric acid base)
- Recommended for raising pH => positive pH (sodium carbonate or bicarbonate)

ORP chemical products:

- **ABSOLUTELY** not recommended => all types of organic chlorine

The pH / ORP probes are subject to wear and tear and therefore are not covered by the warranty.

2. INSTALLATION INSTRUCTIONS

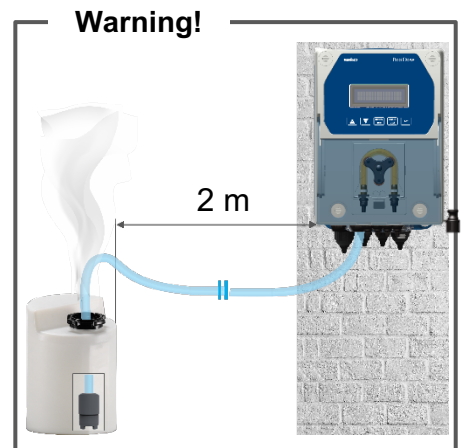
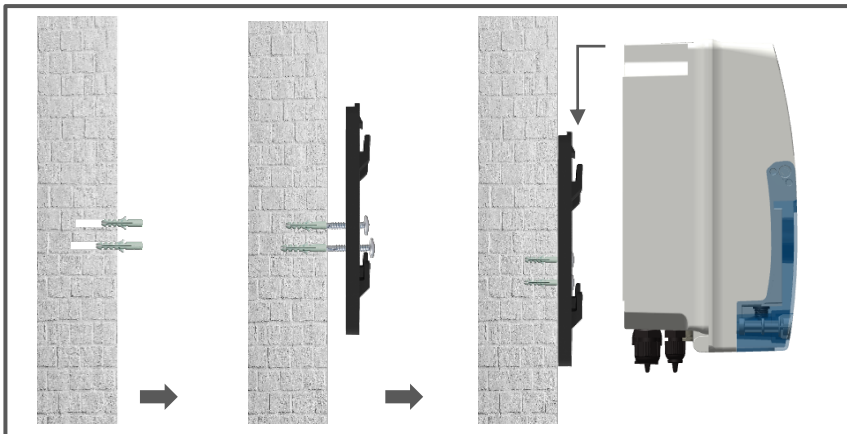

Make sure that the injection pressure is below 1.5 bar

Probe positioning

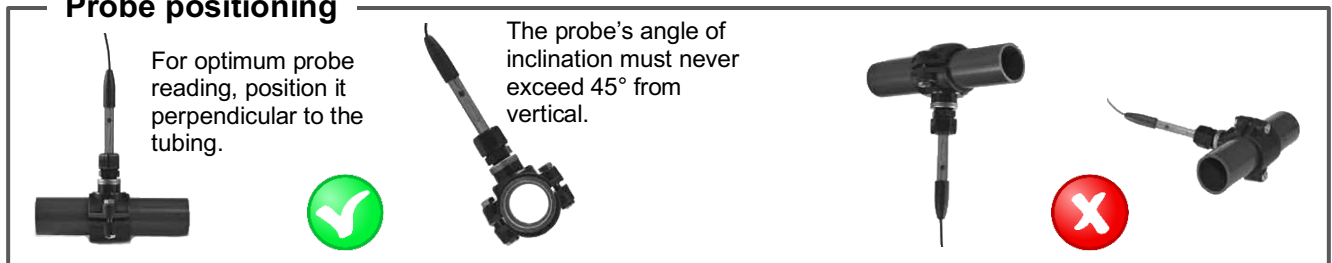

Installation plant

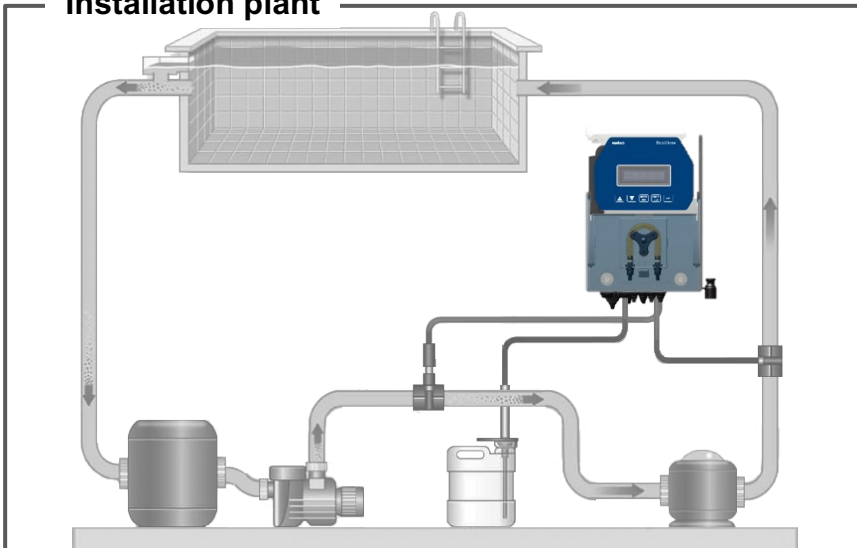

Warning!

Use with salt chlorinator:

For the pH systems, to prevent the risk of system malfunctioning or damage, observe the following instructions:

1. Position the pH measuring probe prior to the chlorinator cell.
2. To eliminate eddy currents, connect the pool water to an electrical ground point
3. Position the product injection point after the chlorinator cell.

3. ELECTRICAL CONNECTIONS

Connect the power supply cable to the mains and the servocontrol pre-wired cable to the auxiliary contact of the filter box (230 Vca).

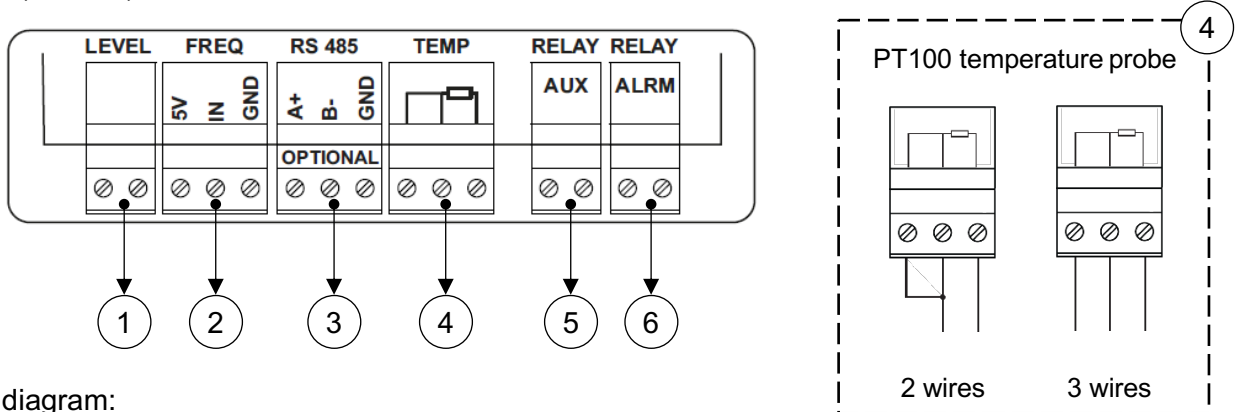

Wiring diagram:

1. Input Level Probe (Product Tank)
2. Input Frequency signal by Water meter pulse sender
3. RS485 Serial Port (optional)
4. Input Temperature Probe (PT100 sensor not included)
5. Output Relay Auxiliary Pump (Dry contact, Relay 250 Vac 10 A)
6. Output Relay Alarm remote (Dry contact, Relay 250 Vac 10 A)

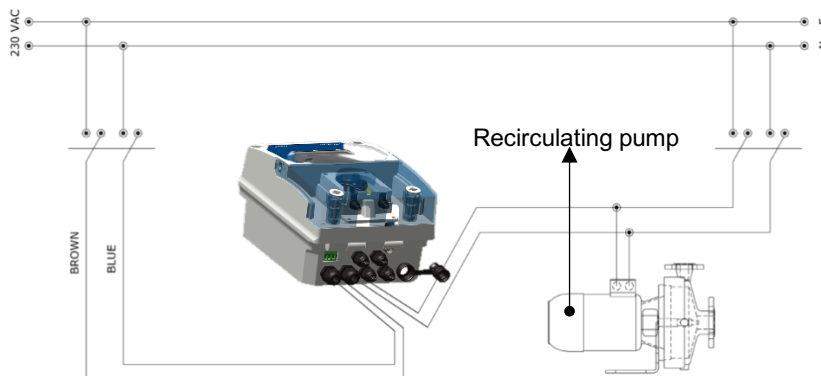

4. TECHNICAL SPECIFICATIONS

Specifications	PoolDose pH	PoolDose ORP
Measure range	3.0 ÷ 10.0 pH; 0...+55°C	200 ÷ 999 mV, 0...+55°C
Set Point range	6.0 ÷ 8.0 pH	400 ÷ 850 mV
Alarm range	6.0 ÷ 8.0 pH	600 ÷ 800 mV
Accuracy	± 0.04 pH; ±0.5°C	± 2 mV; ±0.5°C
Resolution	0.1 pH, ±1°C	10 mV; ±1°C
Power supply	220-240 Vac 50-60 Hz	
Insulation class	II	
Consumption	10 W	
Pump flow rate	1,5 l/h	
Max. back-pressure	1,5 bar	
Probe calibration	Automatic	
Pump state	Proportional dosing	
Peristaltic tube (ID x OD mm)	Santoprene 6 x 9 mm	
Dimensions (H x W x D mm)	224 x 165 x 126 mm	
Weight	3.0 kg	

(Note: the pH measurement is temperature compensated at 25 °C; range temperature measure: 0...+55°C)

5. SETUP INSTRUCTIONS POOLDOSE SYSTEM

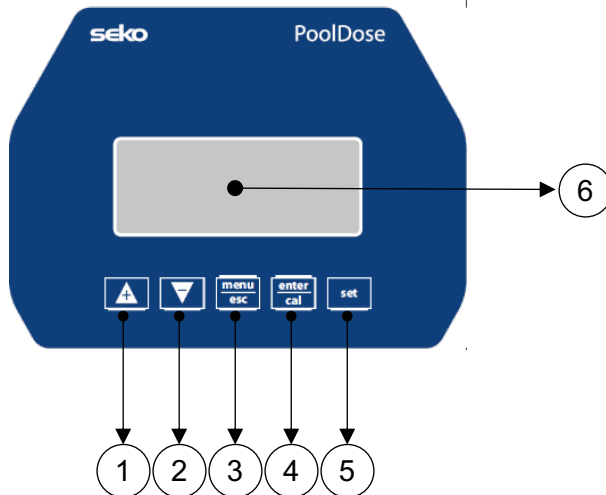

- 1) Button to increase the value
- 2) Button to decrease the value
- 3) Button Menu/Esc
- 4) Button Cal/OK
- 5) Button to set the setpoint
- 6) Digital display

Program Setup – Press **menu/esc** for 5 seconds

At the entry of each menu item, the parameter can be directly modified using the arrow keys (**▲** and **▼**).

Confirmation of the current setting and switching to the next item is done by pressing the **enter/cal** button.



The menu has a circular structure: once you arrive at last item, the confirmation of the parameter set by pressing **enter/cal**, determines the return to the first menu item.

- 1 LANGUAGE – It is possible to select between 5 available languages: **EN**, FR, IT, DE, ES
- 2 SETPOINT – **7.4pH** (5-9pH) / **700mV** (300-900mV)
- 3 TYPE DOSING – **Acid** (Acid/Alka) / **Low** (Low/High)
- 4 TIME_ON = 30seconds (range from 1 to 360 seconds) * Timed dosing only
- 5 TIME_OFF = 60seconds (range from 1 to 360 seconds)
- 6 ADVANCED MENU

- 4.1 SELECT MEASURE – (pH/ORP)
- 4.2 CIRCULATION PUMP – (Enabled/disabled)
- 4.3 TEMP. COMPENSATION – (Auto/Manual 25°C, **range 15...45°C**)
- 4.4 TEMP. PROBE CALIBRATION – Reference (PT100 sensor) or Disabled
- 4.5 OFA_OFF – (0-60min.)
- 4.6 INPUT FLOWRATE
 - Pulse/ liter 1:1
 - Unit measure m³, l.
- 4.7 CALIBRATION
 - Two points
 - Single point
 - Referece
- 4.8 PERISTALTIC DOSING TYPE
 - On/Off
 - Timed
 - Prop
 - Off
- 4.9 AUX RELAY (Off/On)

PoolDose | pH · ORP





Save and exit Program setup – Press 

Pressing the  key determines the exit from the programming menu with saving of the parameters, if the parameter of the menu item in which one is in has not been changed when pressing the  key.



Set Point adjustment

Press the  button for 3 seconds, use  and  to set the desired value.

Stand-by mode (backlight on)

Press  and  buttons simultaneously for 5 seconds to switch off the unit backlight. Dosage and calibration are disabled. To exit standby, press  and  buttons simultaneously.

Priming

Only while the pump is in stand-by press down  and  in the same time.





Flowrate counter reset

To reset value of "Partial Totalizer" press  button for 3 seconds, in stand-by mode only.

OFA reset

Press the  esc button for one click, reset countdown value.

Offset/Slope Menu

Press  and  buttons the unit show Offset/Slope calibration value, press  or  to scroll the menu.

Note: Timeout setting menu, after 120 seconds without action the controller escape itself without saving parameters.

Display example:

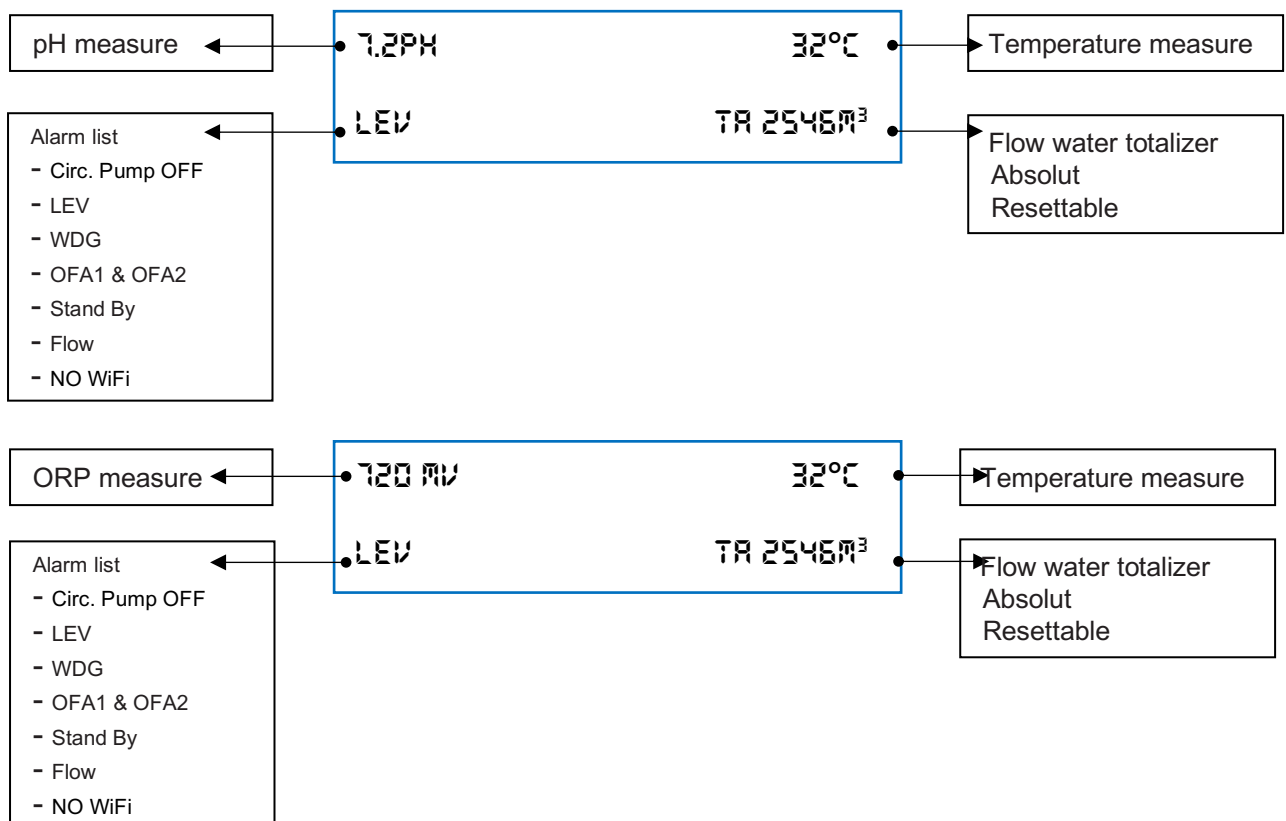

6. INTERNAL WEB SERVER

Download **SekoLink**

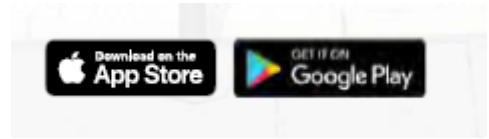

Register your account

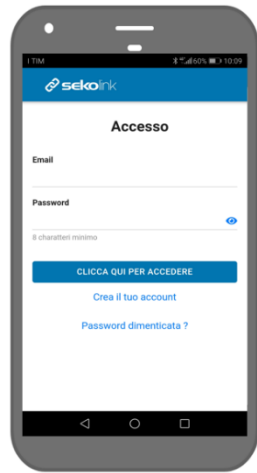

Thanks to QrCode login in internal webpages

Set:

User= ADMIN
Psw= 0000



Set your WiFi lan name and Password and confirm.



Complete your device registration

PoolDose | pH · ORP

Thanks to your registration it is possible to use **sekolink** and **sekoweb** free of charge.



sekolink

Thanks to **sekolink** it is possible to manage your pool:

- Monitoring and limited management
- Smartphone app compatible with iPhone or Android
- For end users



sekoweb

Use **sekoweb** address link www.sekoweb.com or APP to manage your pools with professional webportal:

- Monitoring and complete management
- Internet portal accessible via online login or by scanning a product's QR code
- For pool and spa installers, technicians and engineers



7. pH CALIBRATION

Note: If you have selected the “1 point cal.”, the calibration will be made only in 1 point using the 7 pH buffer solution.

Reference calibration

CAL Reference
7.2 pH

The unit will flash a temperature value
Set the temperature value measured with the instrument
Ex. 7.4 pH

CAL Reference
7.4 pH

enter cal

↓

8. ORP CALIBRATION

9. TEMPERATURE CALIBRATION

CAL Reference
26°C

The unit will flash a temperature value
Set the temperature value measured with the instrument
Ex. 27°C

CAL Reference
27°C

enter
cal

10. PROPORTIONAL DOSING

Setpoint = 7.4 pH

Dosing mode = Acid

Proportional band: 1,5 pH (non-modifiable value)

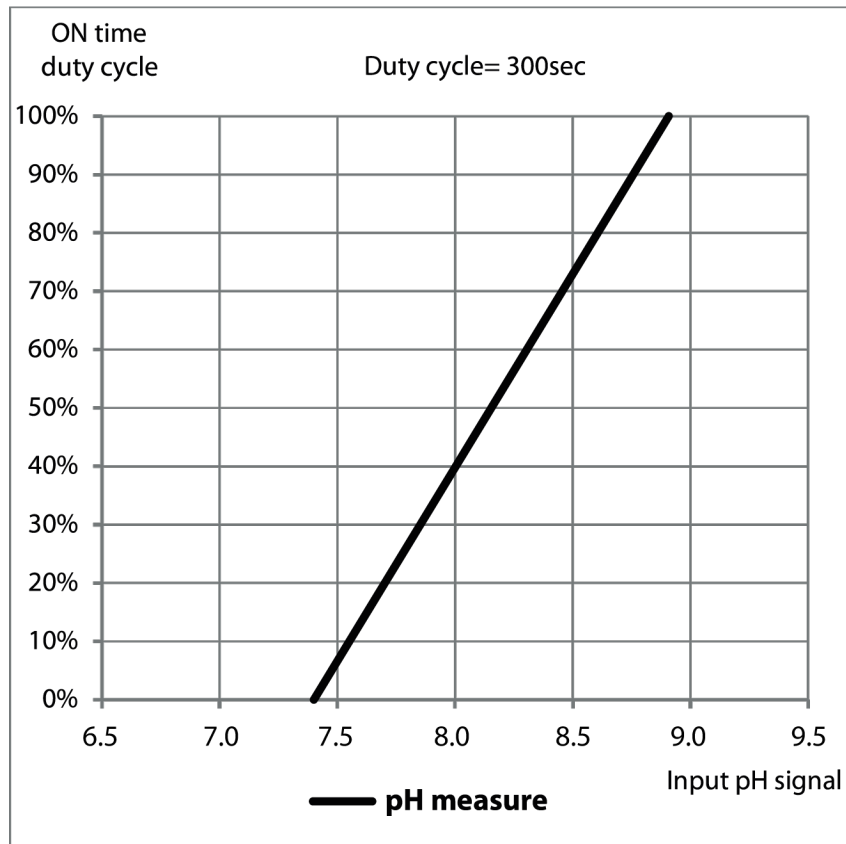



Setpoint = 700 mV

Dosing mode = Low

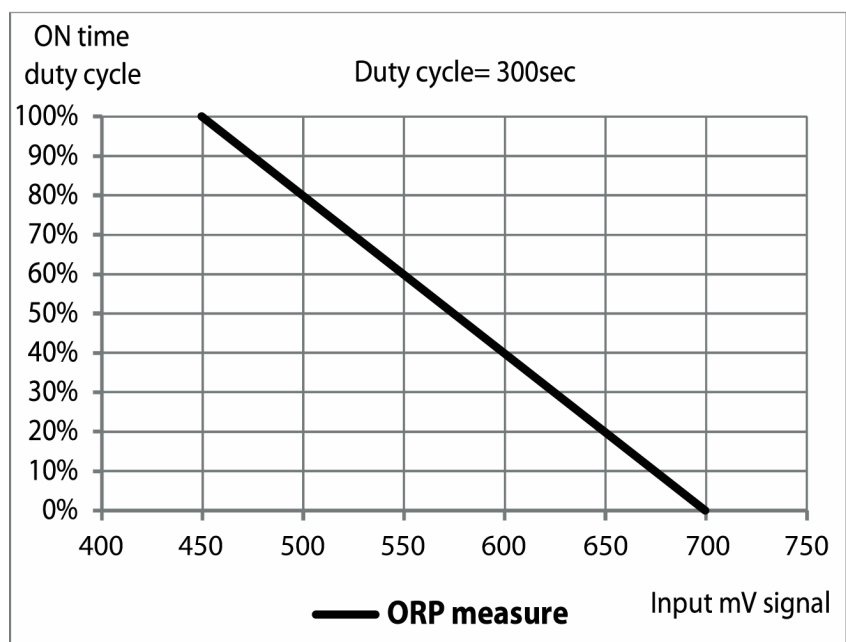



Proportional Band= 250 mV (non-modifiable value)



11. ALARMS

Alarm	Display PoolDose pH	Display PoolDose ORP	Actions to do
Level	TANK LEVEL LOW	-	- Restore Product tank
Measure out of range	MEASURE TOO LOW (<6 pH) MEASURE TOO HIGH (>8 pH)	MEASURE TOO LOW (<600 mV) MEASURE TOO HIGH (>800 mV)	- Replace or check the measure probe - Restore pH / ORP measure
OFA Alarm (time > OFA time)	OFA	-	- Push  to reset
Flow Rate	FILTRATION OFF	-	- Restore Flow Rate
Calibration Function	ERROR_____4_PH ERROR_____7_PH CALIBRAT_____PH7	ERROR_____700_MV	- Restore Probe or Buffer solution and repeat calibration procedure
System Error	PARAMETERS ERROR		- Press  to restore Default parameter - Broken Unit
Modbus Error	WDG		- Press  to reset - Restore communication

To restore the default parameters, follow the steps below:

- Power off the PoolDose unit
- Keep  and  pressed and power on the unit
- The unit will flash INIT.DEFAULT__NO
- Press  INIT.DEFAULT__YES
- Press  to restore the default parameters.

Default Parameters	PoolDose pH	PoolDose ORP
Language	EN	
Time OFA	OFF	
Flow Input	OFF	
Set Point value	7.4 pH	700 mV
Calibration	7 pH / 4 pH (2-point)	475 mV
Dosing Method	Acid	Low

Alarm measure:

n	Item	Limits
1	Temp. Measure min	+10°C
2	Temp. Measure Max	+38°C
3	pH Measure min	6 pH
4	pH Measure Max	8 pH
5	ORP Measure min	+600 mV
6	ORP Measure Max	+800 mV

12. HANDLING

Hose replacement:

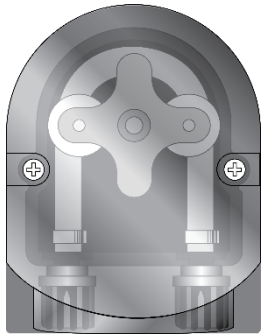

Open the pump's lid and release the hose by pulling the left connector upward.

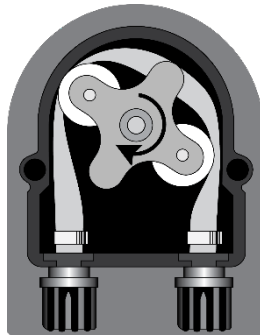

Position the roller at 7h05, turning it in the direction of the circular arrow.

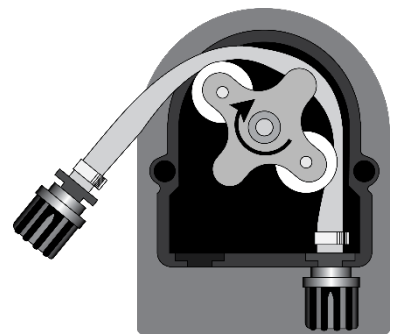

Completely release the left connector, holding it taut towards the outside, and turn the roller in the direction of the circular arrow so that the hose is freed up to the right connector.

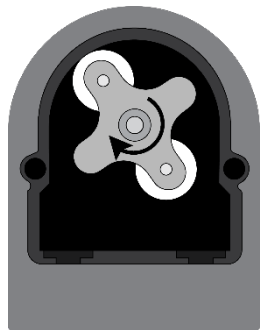

Position the roller at 7h05, turning it in the direction of the circular arrow.

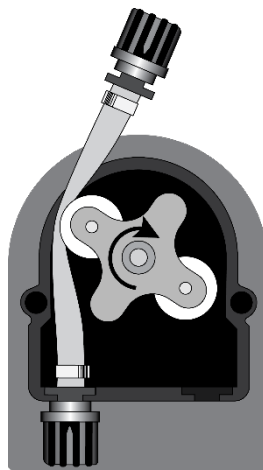

Insert the left connector into the relative housing and pass the hose under the roller's guide. Turn the roller in the direction of the circular arrow, simultaneously accompanying the hose into the pump's head, until the right connector is reached.

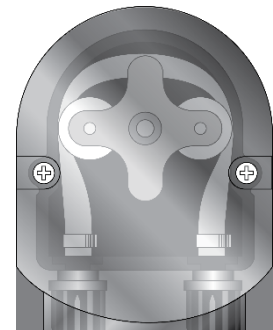

Close the pump's lid and press its surface hard so that it is properly locked into place.

PoolDose | pH · ORP

Wires connections:

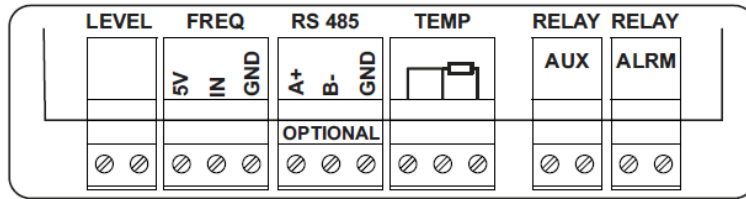

Item	Description	Terminal Block
Level input:	Input level probe for chemical tank	
Frequency input:	Frequency signal Input for Water meter A: Mechanical water meter with reed sensor B: Padwheel water meter with hall sensor	
Serial Port	Not Present , Optional function	Not Present
Temperature sensor input:	Input temperature sensor two or three cable: A: Temperature probe with two wires B: Temperature probe with three wires	
Aux Relay Output	Dry contact relay for additional external device	
Alarm Relay Output	Dry contact relay for Alarm remote	













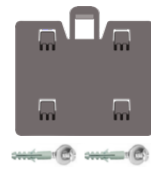



ACHTUNG!

Vor jeder Maßnahme innerhalb der Steuertafel des PoolDose ist sicherzustellen, dass diese Vorrichtung vom Netz getrennt ist.

Die Nichteinhaltung der in dieser Anleitung enthaltenen Anweisungen kann zu Personenschäden, Schäden am Gerät und Schäden am System führen.

1. LIEFERUMFANG

 A: Selbstschneidende Rohrschlauchklemme zum Befestigen des PSS3 auf dem 2"-Schlauch (φ=50 mm)	 B: Fußfilter (PP-Rohr)	 C: Halterungssatz (φ= 6 mm-Schrauben)	 D: FPM-Lippenventil (3/8" GAS)	 E: PSS3-Sondenträger (1/2" GAS)
 F: pH-Sonde	 G: Redox-Sonde	 H: Pufferlösung pH 7	 I: Pufferlösung pH 4	 J: Kalibrierlösung 465 mV
 K: Wasser	 L: 4x6 (IDxOD mm) PVC-Schlauch (4m)	 M: 4x6 (IDxOD mm) PE-Schlauch (5m)	 N: Reduzierstück für Einspritzventil (1/2" außen auf 3/8" innen)	 O: Temperaturfühler (1/2" M)

System \ Artikel*	A	B	C	D	E	F	G	H	I	J	K	L	M	N	O
PoolDose pH	2 ^(*1)	1	1	1	1	1	-	1	1	-	1	1	1	1	1 ^(*2)
PoolDose ORP	2 ^(*1)	1	1	1	1	-	1	-	-	1	1	1	1	1	1 ^(*2)

* Die Zahlen in der Tabelle geben die Anzahl der jeweiligen Artikel im Lieferumfang an.

(*1 Drei Stücke für das WiFi-Modell)

(*2 Ein Stück für das WiFi-Modell)

PoolDose | pH · ORP

ACHTUNG!

Diese Produkte sind **GEFÄHRLICH** und der Umgang mit ihnen, der Gebrauch und die Lagerung erfordern besondere Vorsichtsmaßnahmen.

- **Chemikalien NIEMALS miteinander vermischen.**
- NIEMALS Kinder oder mit dieser Anleitung nicht vertraute Personen die Vorrichtung PoolDose oder zugehörige Komponenten einschließlich der Chemikalien verwenden oder damit hantieren lassen.

pH-Werte der Chemikalien:

- **ABSOLUT** nicht empfohlen => reine Schwefelsäure
- Zum Senken des pH-Werts wird ein negativer pH-Wert empfohlen (auf der Grundlage von Schwefelsäure).
- Zum Erhöhen des pH-Werts wird ein positiver pH-Wert empfohlen (Natriumcarbonat oder Bicarbonat)

ORP-Werte der Chemikalien:

- **ABSOLUT** nicht empfohlen => Alle Arten organischer Chlorverbindungen

Alle pH- und ORP-Sonden sind **Verschleißteile** und daher von jeglicher Garantie ausgeschlossen.

2. EINBAUANLEITUNG

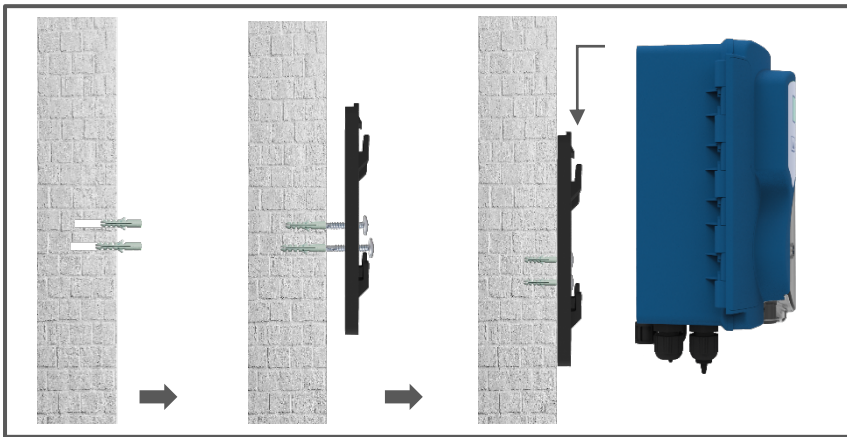

Vergewissern Sie sich, dass der Einspritzdruck weniger als 1,5 bar beträgt

Positionierung der Messsonde

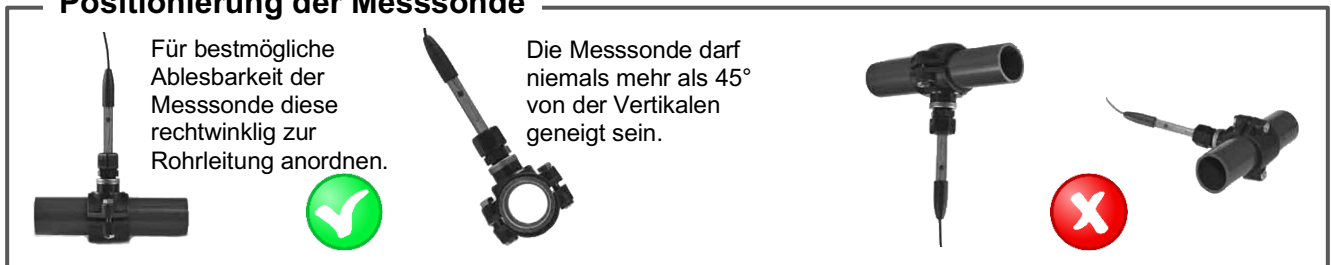

Anlagenaufbau

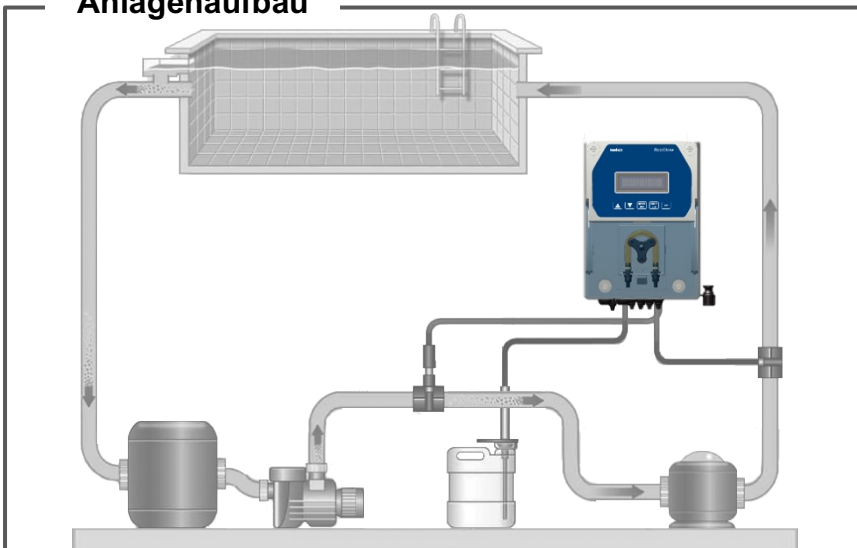

Achtung!

Verwendung mit Salzchlorungsmittel:

Um bei pH-Systemen Systemstörungen und Systemschäden vorzubeugen, ist Folgendes zu beachten:

1. Die pH-Messsonde vor der Chlorierungszelle positionieren.
2. Zur Vermeidung von Fehlerströmen das Poolwasser erden.
3. Den Einspritzpunkt für das Mittel hinter der Chlorierungszelle positionieren.

3. ELEKTRISCHE ANSCHLÜSSE

Das Netzstromkabel an das Netz und das vorgefertigte Servo-Steuerungskabel an den Hilfskontakt der Filterbox (230 Vca) anschließen.

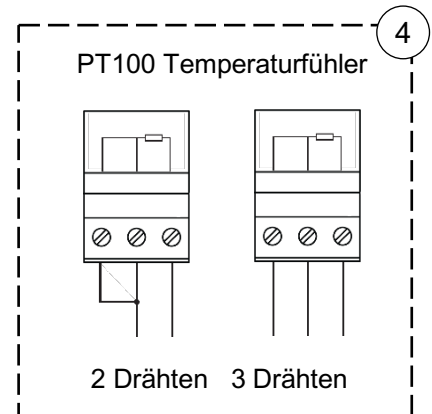
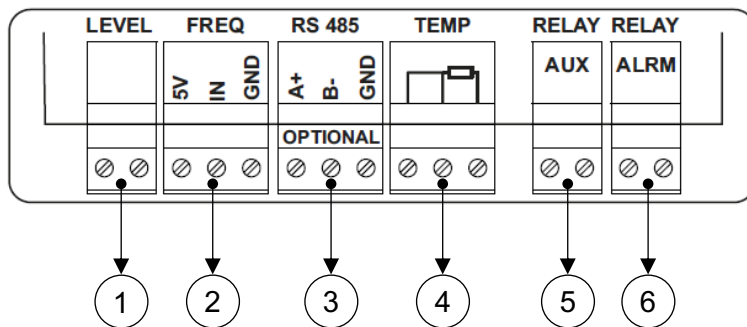

Schaltplan:

1. Eingang Füllstandsonde (Mittelbehälter)
2. Eingangsfrequenzsignal vom Impulsgeber des Wasserzählers
3. RS485 Serieller Port (optional)
4. Eingang Temperaturfühler (PT100 Temperaturfühler)
5. Ausgangsrelais Hilfspumpe (Trockenkontakt, Relais 250 Vac 10 A)
6. Ausgang Fernalarmrelais (Trockenkontakt, Relais 250 Vac 10 A)

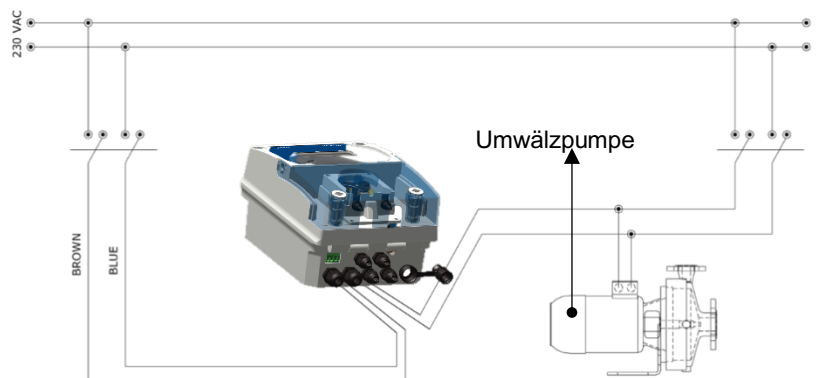

4. TECHNISCHE DATEN

Daten	PoolDose pH	PoolDose ORP
Messbereich	3.0 ÷ 10.0 pH; 0...+55°C	200 ÷ 999 mV, 0...+55°C
Sollwertbereich	6.0 ÷ 8.0 pH	400 ÷ 850 mV
Alarmbereich	6.0 ÷ 8.0 pH	600 ÷ 800 mV
Genauigkeit	± 0.04 pH; ±0.5°C	± 2 mV; ±0.5°C
Genauigkeit des Geräts	0.1 pH, ±1°C	10 mV; ±1°C
Stromversorgung	220-240 Vac 50-60 Hz	
Schutzklasse	II	
Verbrauch	10 W	
Durchfluss Pumpe	1,5 l/h	
Max. Gegendruck	1,5 bar	
Sondenkalibrierung	Automatisch	
Pumpenstatus	Proportionale Dosierung	
Peristaltik-Schlauch (ID x OD mm)	Santoprene 6 x 9 mm	
Abmessungen (H x B x T mm)	224 x 165 x 126 mm	
Gewicht	3.0 kg	

(Hinweis: Die pH-Messung wird bei 25°C temperaturkompensiert; Bereichstemperaturmessung: 0...+55°C)

5. SETUP-ANLEITUNGEN POOLDOSE-SYSTEM

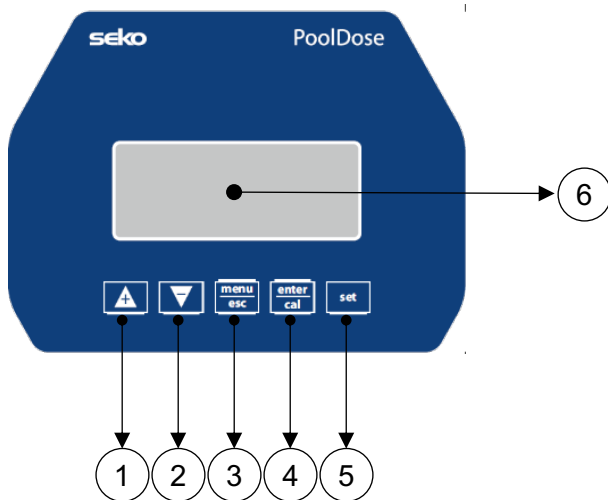

- 1) Taste zur Erhöhung des Wertes
- 2) Taste zum Verringern des Wertes
- 3) Taste Menü/Esc
- 4) Taste Cal/OK
- 5) Taste zum Einstellen des Sollwerts
- 6) Digitalanzeige

Programm-Einstellung - 5 Sekunden **menu/esc** lang gedrückt halten



Bei der Eingabe jedes Menüpunktes kann der Parameter direkt mit den Pfeiltasten geändert werden (**▲** und **▼**). Die Bestätigung der aktuellen Einstellung und das Umschalten zum nächsten Punkt erfolgen durch Drücken der Taste **enter/cal**.

Das Menü ist kreisförmig aufgebaut: Wenn Sie den letzten Punkt erreicht haben, bestimmt die Bestätigung der Parametereinstellung durch Drücken von **enter/cal** die Rückkehr zum ersten Menüpunkt.

- 1 **SPRACHE**: - Es stehen fünf Sprachen zur Verfügung, aus denen gewählt werden kann: **EN**, FR, IT, DE, ES, RU
- 2 **SOLLWERT** – **7.4 pH** (5-9 pH) / **700 mV** (300-900 mV)
- 3 **ART_DOSIERUNG** – **Säure** (Sauer/Alka) / **Niedrig** (Niedrig/Hoch)
- 4 **ZEIT_AN** = 30 Sekunden (Bereich von 1 bis 360 Sekunden) * Nur zeitgesteuerte Dosierung
- 5 **ZEIT_AUS** = 60 Sekunden (Bereich von 1 bis 360 Sekunden)
- 6 **ERWEITERTES MENÜ**
 - 4.1 **WAHLEN SIE MESSEN** – (pH/ORP)
 - 4.2 **UMWALZPUMPE** - (aktiviert/deaktiviert)
 - 4.3 **TEMP. KOMPENSATION** - (Auto/Manuell 25°C)
 - 4.4 **TEMP. SONDENKALIBRIERUNG** – Referenz (PT100 Sensor) oder Deaktiviert
 - 4.5 **OFR_AUS** – (0-60Min.)
 - 4.6 **EINGANG DURCHFLUSSMENGE**
 - Impuls/Liter 1:1
 - Einheit Messung m³, l.
 - 4.7 **KALIBRIERUNG**
 - Zwei Punkte
 - Einfachpumpe
 - Referenz
 - 4.8 **SCHLAUCHDOSIERUNG**
 - On/Off (Ein/Aus)
 - Zeitgesteuert
 - Prop
 - Off (Aus)
 - 4.9 **AUX RELAIS** (Ein/Aus)

PoolDose | pH · ORP





Off/AusSpeichern und Programm verlassen -  drücken

Durch Drücken der Taste  wird das Programmiermenü mit Speichern der Parameter verlassen, wenn der Parameter des Menüpunktes, in dem man sich befindet, beim Drücken der Taste nicht geändert wurde .

Sollwerteinstellung

Die  -Taste 3 Sekunden lang drücken,  und  verwenden, um den gewünschten Wert einzustellen.

Standby-Modus (Hintergrundbeleuchtung an)

Die Tasten  und  gleichzeitig 5 Sekunden lang drücken, um die Hintergrundbeleuchtung des Geräts auszuschalten. Dosierung und Kalibrierung sind deaktiviert. Um den Bereitschaftszustand zu verlassen, die Tasten  und  gleichzeitig drücken.

Vorbereitung

Mit in Stand-by befindlicher Pumpe  und  gleichzeitig nach unten drücken.





Durchflussmengenzähler Reset

Um den Wert des „Permanentzählers“ zurückzusetzen, drücken Sie die  Taste 3 Sekunden lang, nur im Standby-Modus.

OFA-Reset

Drücken Sie einmal , um den Countdown-Wert zurückzusetzen.

Offset/Slope (Neigungs)-Menü

Drücken Sie die Tasten  und , bis das Gerät den Wert für die Offset-/Slopekalibrierung anzeigt. Drücken Sie  oder , um durch das Menü zu scrollen.

Hinweis: Timeout-Einstellungsmenü: Nach 120 Sekunden ohne Aktion wird der Controller ohne Speichern von Parametern beendet.

Anzeigebeispiel:

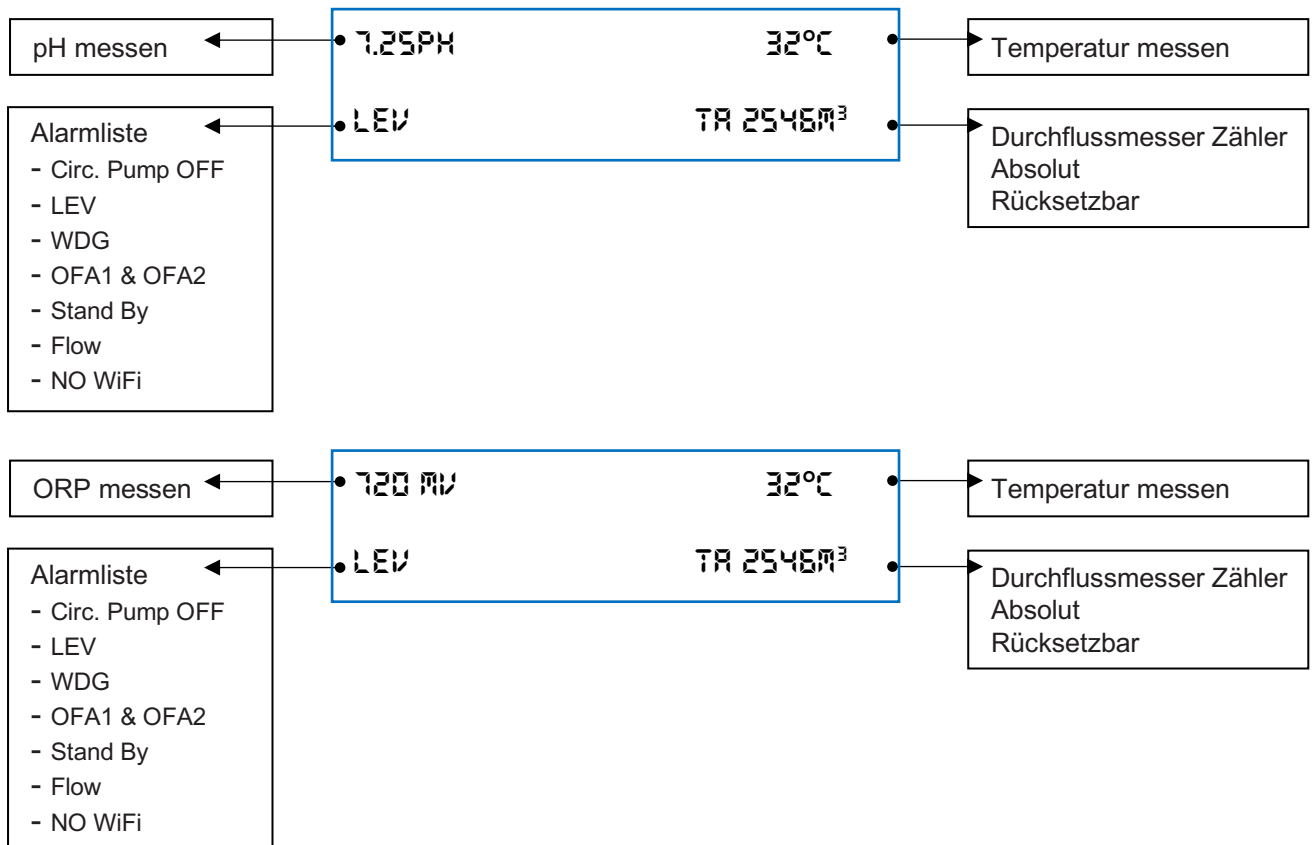

6. INTERNER WEBSERVER

Herunterladen **SekoLink** Anwendung



Registrierte dein Konto

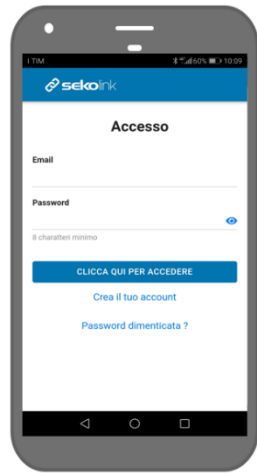

Mit Hilfe der QrCode, loggen Sie sich in den internen Web-Seiten Set:

User name= ADMIN
Password= 0000



Stellen Sie Ihr WiFi-LAN Name und Passwort ein und bestätigen.



Füllen Sie das Geräteregistrierung

PoolDose | pH · ORP

Dank Ihrer Registrierung können Sie **sekolink** und **sekoweb** kostenlos nutzen.



sekolink

Dank der **sekolink** APP Sie Ihren Pool steuern:

- Überwachung und begrenzte Verwaltung
- Smartphone-App kompatibel mit iPhone oder Android
- Für Endbenutzer













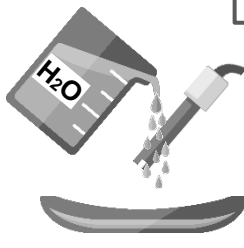
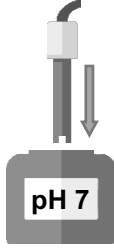
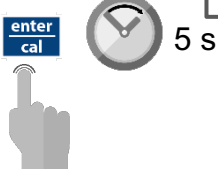

sekoweb

Verwenden Sie die **sekoweb**-Adresse www.sekoweb.com oder die APP, um Ihre Pools mit einem professionellen Webportal zu verwalten:

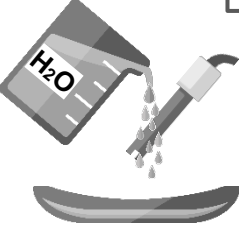
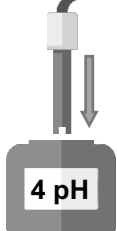
- Überwachung und vollständige Verwaltung
- Internetportal zugänglich über Online-Anmeldung oder durch Scannen eines QR-Code des Produkts
- Für Pool- und Spa-Installateure, Techniker und Ingenieure

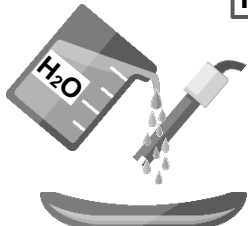

7. pH-KALIBRIERUNG

 <p>1</p>	 <p>2</p>	 <p>3</p>	 <p>4</p>
 <p>5 s</p> <p>enter cal</p> <p>pH-Kalibrierung einstellen</p>	 <p>enter cal</p> <p>pH 7-Kalibrierung</p>	 <p>60 s</p>	 <p>7 pH Quality probe 100 %</p>
 <p>9</p>	 <p>10</p> <p>4 pH</p>	 <p>enter cal</p> <p>pH 4-Kalibrierung</p>	 <p>60 s</p>
 <p>4 pH Quality probe 100 %</p>	 <p>14</p>	 <p>15</p>	 <p>enter cal</p> <p>Speichern und verlassen</p>

Hinweis: Wenn Sie das „1 Punkt Kal.“ Ausgewählt haben, wird die Kalibrierung nur in 1 Punkt unter Verwendung der 7 pH-Pufferlösung hergestellt werden.

Referenzkalibrierung

<p>Referenz KAL 7.2 pH</p> <p>Das Gerät blinkt einen Temperaturwert Stellen Sie den Temperaturwert mit dem Instrument gemessen Ex. 7.4 pH</p>	<p>Referenz KAL 7.4 pH</p> <p>enter cal</p> 
--	--

8. ORP-KALIBRIERUNG

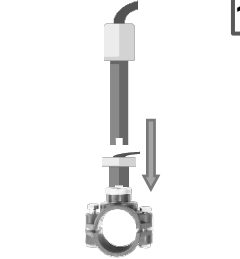
 <p>1</p>	 <p>2</p>	 <p>3</p>	 <p>4</p>
 <p>5</p> <p>enter cal 5 s</p> <p>ORP-Kalibrierung einstellen</p>	 <p>6</p> <p>enter cal</p> <p>465 mV-Kalibrierung</p>	 <p>7</p> <p>60 s</p>	 <p>8</p> <p>465 mV Quality probe 100%</p>
 <p>9</p>	 <p>10</p>	 <p>11</p> <p>enter cal</p> <p>Speichern und verlassen</p>	

9. TEMPERATURKALIBRIERUNG

<p>Referenz KAL 26°C</p> <p>Das Gerät blinkt einen Temperaturwert Stellen Sie den Temperaturwert mit dem Instrument gemessen Ex. 27°C</p>	<p>Referenz KAL 27°C</p>  <p>enter cal</p>
---	---

10. PROPORTIONALE DOSIERUNG

Sollwert = 7,4 pH

Dosiermodus = Säure

Proportionalband = 1,5 pH (nicht veränderbarer Wert)

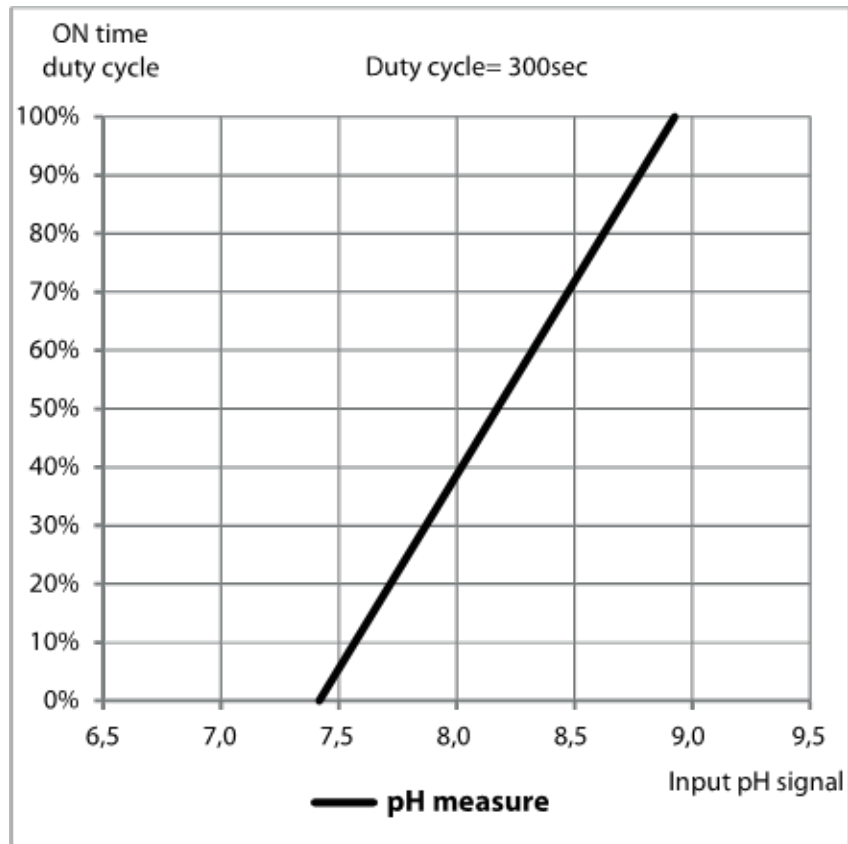



Sollwert = 700 mV

Dosiermodus = Niedrig

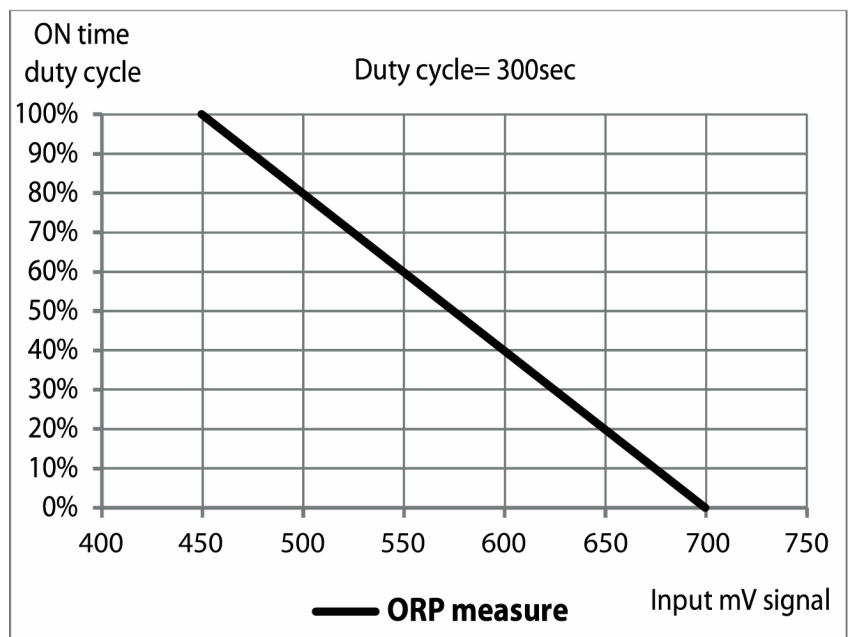



Proportionalband = 250 mV (nicht veränderbarer Wert)



11. ALARME

Alarm	Display PoolDose pH	Display PoolDose ORP	Maßnahmen
Füllstand	TANK FULLSTAND NIEDRIG	-	- Produktbehälter zurücksetzen
Messung außerhalb des zulässigen Bereichs	MESSUNG ZU NIEDRIG (<5 pH) MESSUNG ZU HOCH (>9pH)	MESSUNG ZU NIEDRIG (<600 mV) MESSUNG ZU HOCH (>800 mV)	- Den Messfühler prüfen, ggf. ersetzen - pH-/ORP-Messgröße wiederherstellen
OFA-Alarm (Zeit > OFA-Zeit)	OFA	-	- Zum Zurücksetzen  drücken
Durchfluss	FILTRATION AUS	-	- Durchfluss wiederherstellen
Kalibrierfunktion	FEHLER _____ 7_PH FEHLER _____ 4_PH KALIBRIER _____ PH7	FEHLER _____ 700_mV	- Sonde oder Pufferlösung ersetzen und neu kalibrieren
Systemfehler	PARAMETERFEHLER		-  drücken, um zum Standardparameter zurückzukehren - Gerät defekt
Modbus-Fehler	MOD6		- Zum Zurücksetzen  drücken - Kommunikation wiederherstellen

Um zur Standardeinstellung zurückzukehren, wie folgt vorgehen:

- Die PoolDose -Einheit ausschalten
-  und  gedrückt halten und Strom wieder einschalten
- Das Gerät blinkt mit INIT.DEFAULT__NEIN
-  INIT.DEFAULT__JA drücken
-  drücken, um die Standardparameter wiederherzustellen.

Standardeinstellung	PoolDose pH	PoolDose ORP
Sprache	EN	
OFA-Zeit	AUS	
Durchflusseingang	AUS	
Sollwert	pH 7,4	700 mV
Kalibrierung	7 pH / 4 pH (2-Punkt)	465 mV
Dosierverfahren	Säure	Niedrig

Alarm Messungen:

n	Item	Grenzen
1	Temp.- Messung min	+10°C
2	Temp.- Messung Max	+38°C
3	pH-Messung min	6 pH
4	pH- Messung Max	8 pH
5	ORP- Messung min	+600 mV
6	ORP- Messung Max	+800 mV

12. HANDHABUNG

Ersetzen der Schläuche:

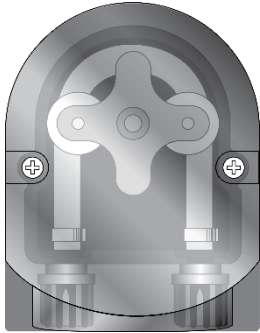

Den Pumpendeckel öffnen und den Schlauch durch Hochziehen des linken Anschlusses freigeben.

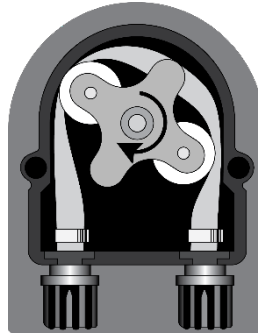

Den Rotor auf 7:05 Uhr stellen, dazu in Richtung des kreisförmigen Pfeils drehen.

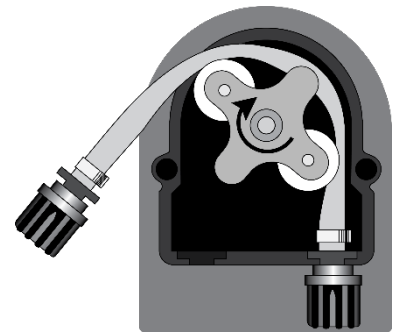

Den linken Anschluss vollständig freigeben und dabei leicht nach außen ziehen und den Läufer in Richtung des kreisförmigen Pfeils drehen, so dass der Schlauch am rechten Anschluss freigegeben wird.

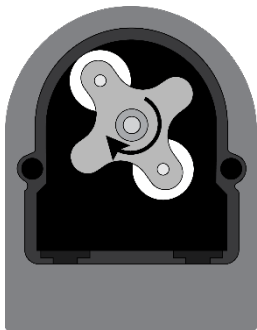

Den Läufer auf 7:05 Uhr stellen, dazu in Richtung des kreisförmigen Pfeils drehen.

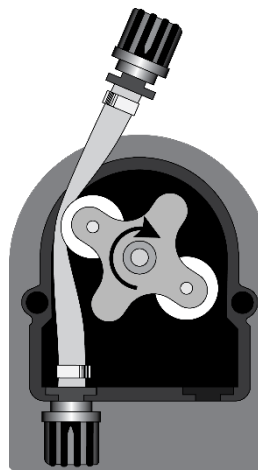

Den linken Anschluss in sein Gehäuse schieben und den Schlauch unter der Läuferführung durchschieben. Den Läufer in Richtung des kreisförmigen Pfeils drehen und dabei gleichzeitig den Schlauch in den Pumpenkopf einführen, bis der rechte Anschluss erreicht wird.

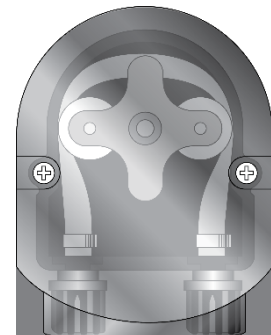

Den Pumpendeckel schließen und fest auf seine Oberfläche drücken, so dass er richtig einrastet.

PoolDose | pH · ORP

Kabelverbindungen:

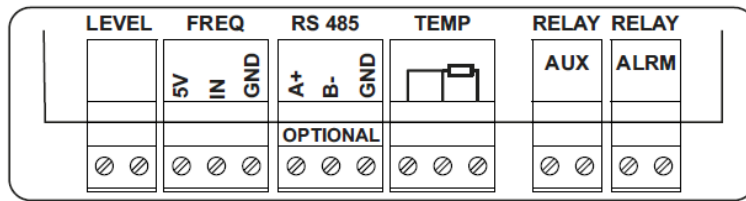

Item	Beschreibung	Klemmenblock
Pegeleingang:	Füllstandsendeneingang für Chemietank	
Frequenzeingang:	Frequenzsignaleingang für Wasserzähler A: Mechanischer Wasserzähler mit Reedsensor B: Padwheel Wasserzähler mit Hallsensor	
Serial Port	Nicht vorhanden , Optional Funktion	Nicht vorhanden
Temperatursensoreingang:	Temperatursensoreingang mit zwei oder drei Drähten: A: Temperaturfühler mit zwei Drähten B: Temperaturfühler mit drei Drähten	
Aux-Relaisausgang	Trockenkontaktrelais für zusätzliches externes Gerät	
Alarmrelaisausgang	Trockenkontaktrelais für Alarm Fern	



¡ADVERTENCIA!

Antes de llevar a cabo CUALQUIER TIPO de trabajo en el interior del panel de control del dispositivo PoolDose, asegúrese de desconectarlo de la fuente de alimentación.

El incumplimiento de las instrucciones recogidas en el presente manual puede ocasionar lesiones a las personas y/o daños al aparato y al sistema.

1. CONTENIDO DEL EMBALAJE

 <p>A: Montura de conexión para asegurar PSS3 en la manguera de 2" (φ=50 mm)</p>	 <p>B: Filtro de fondo (elevador de PP)</p>	 <p>C: Kit del soporte de montaje (φ= tornillos de 6 mm)</p>	 <p>D: Válvula labial FPM (3/8" GAS)</p>	 <p>E: Soporte de sonda PSS3 (1/2" GAS)</p>
 <p>F: Sonda pH</p>	 <p>G: Sonda Redox</p>	 <p>H: Solución tampón pH 7</p>	 <p>I: Solución tampón pH 4</p>	 <p>J: Solución de calibración 465 mV</p>
 <p>K: Agua</p>	 <p>L: Tubo PVC 4x6 (IDxOD mm) (4m)</p>	 <p>M: Tubo PE 4x6 (IDxOD mm) (5m)</p>	 <p>N: Reductor para válvula de inyección (1/2" M hasta 3/8" F)</p>	 <p>O: Sonda de temperatura (1/2" M)</p>

Elemento *	A	B	C	D	E	F	G	H	I	J	K	L	M	N	O
Sistema															
PoolDose pH	2 ^(*1)	1	1	1	1	1	-	1	1	-	1	1	1	1	1 ^(*2)
PoolDose ORP	2 ^(*1)	1	1	1	1	-	1	-	-	1	1	1	1	1	1 ^(*2)

* Los valores de la tabla representan el número de elementos que se encuentran dentro del paquete.
 (*¹ Tres piezas solo para el modelo WiFi)
 (*² Una pieza solo para el modelo WiFi)

¡ADVERTENCIA!

Estos productos son **PELIGROSOS** y requieren precauciones especiales durante su uso, manipulación y almacenamiento.

- **No mezcle NUNCA productos químicos.**
- No permita NUNCA que niños o personas que no hayan leído este manual usen o manipulen PoolDose o alguno de sus componentes periféricos (incluidos los productos químicos).

Productos químicos de pH:

- No recomendado **EN ABSOLUTO** => ácido sulfúrico puro
- Recomendado para reducir el pH => pH negativo (con una base de ácido sulfúrico)
- Recomendado para aumentar el pH => pH positivo (carbonato de sodio o bicarbonato)

Productos químicos ORP:

- No recomendado **EN ABSOLUTO** => cualquier tipo de cloro orgánico

Las sondas de pH/ORP están sujetas a desgaste y deterioro, por lo que no están cubiertas por la garantía.

2. INSTRUCCIONES DE INSTALACIÓN

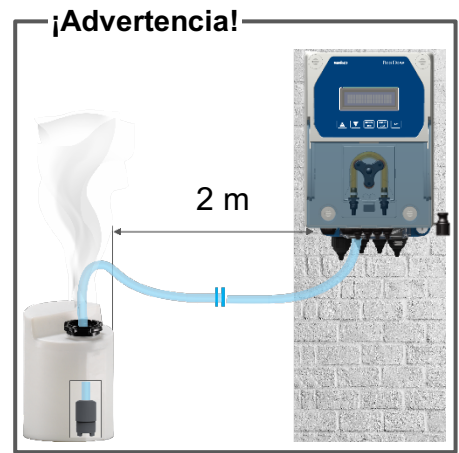
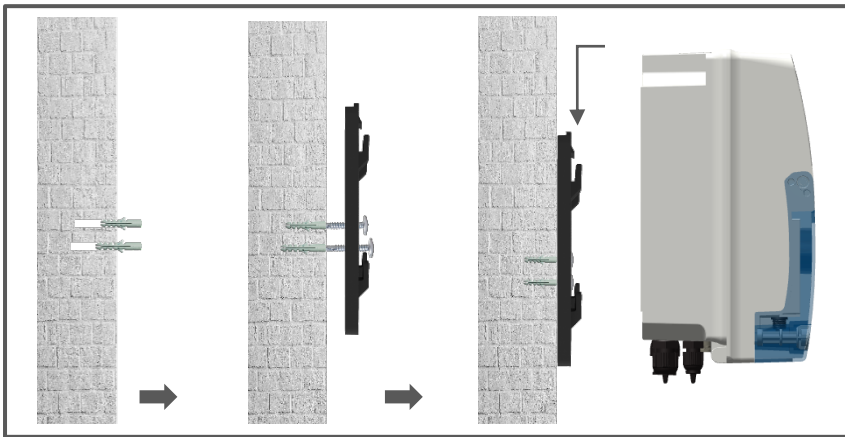

Asegúrese de que la presión de inyección está por debajo de 1,5 bares

Colocación de la sonda

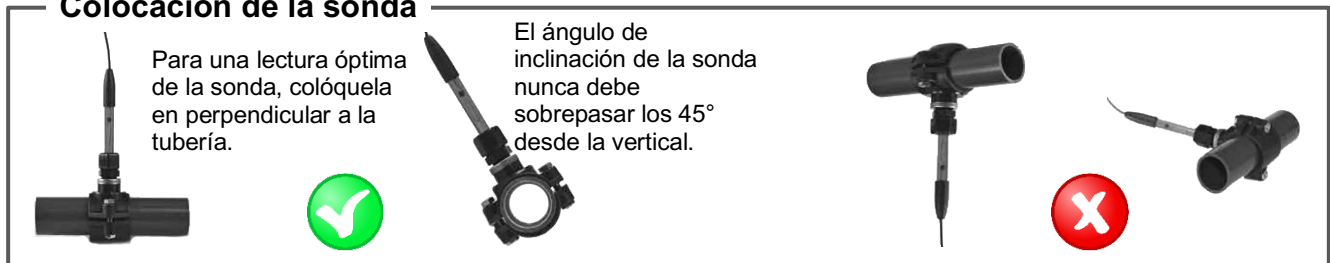

Planta de instalación

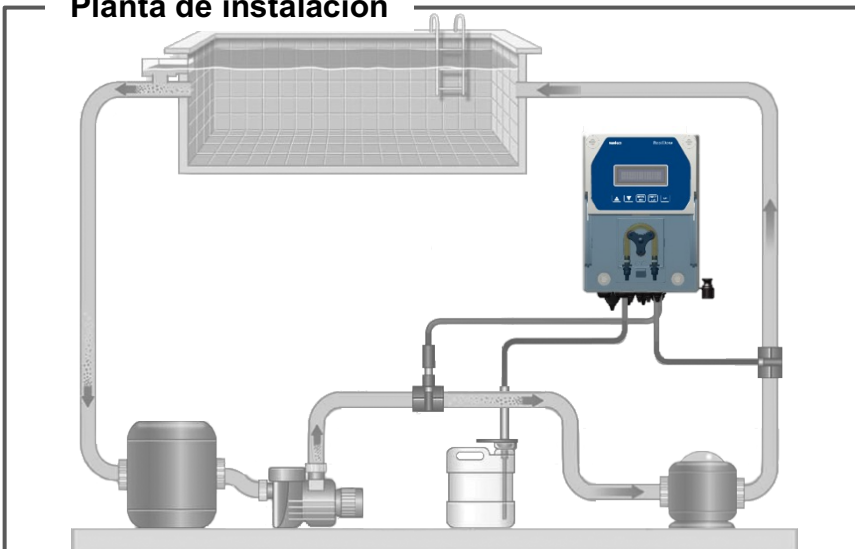

¡Advertencia!

Usar con clorador salino:

En los sistemas de pH, para evitar el riesgo de que el sistema funcione incorrectamente o se dañe, respete las siguientes instrucciones:

1. Coloque la sonda de medición de pH antes de la célula del clorador.
2. Para eliminar las corrientes inducidas, conecte el agua de la piscina a un punto eléctrico de la puesta a tierra
3. Coloque el punto de inyección de producto tras la célula del clorador.

3. CONEXIONES ELÉCTRICAS

Conecte el cable de alimentación a la red eléctrica y el cable previamente conectado del servocontrol al contacto auxiliar de la caja del filtro (230 Vca).



Diagrama de cableado:

1. Entrada de la sonda de nivel (depósito de producto)
2. Entrada señal de frecuencia por transmisor de pulso del medidor de agua
3. Puerto Serial RS485 (opcional)
4. Entrada de la temperatura (sensor PT100 no incluido)
5. Salida relé de bomba auxiliar (contacto seco, relé 250 Vca 10 A)
6. Salida relé de alarma remota (contacto seco, relé 250 Vca 10 A)

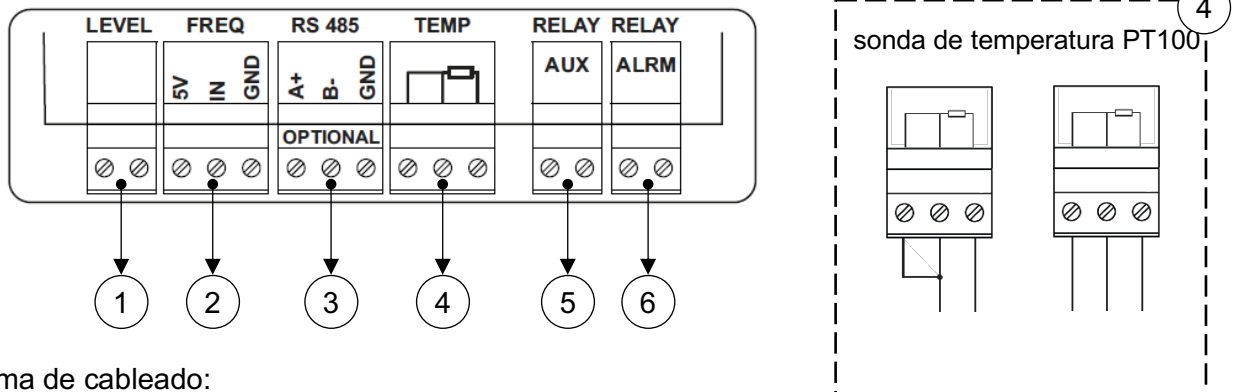
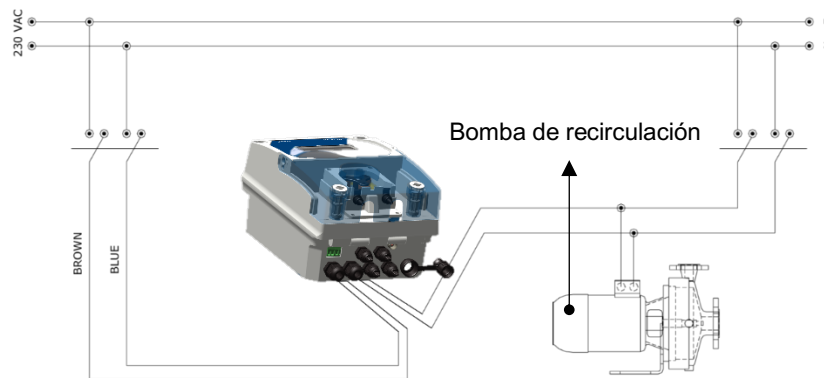

4. ESPECIFICACIONES TÉCNICAS

Especificaciones	PoolDose pH	PoolDose ORP
Rango de medida	3.0 ÷ 10.0 pH; 0...+55°C	200 ÷ 999 mV, 0...+55°C
Rango punto de ajuste	6.0 ÷ 8.0 pH	400 ÷ 850 mV
Rango de alarma	6.0 ÷ 8.0 pH	600 ÷ 800 mV
Fiabilidad	± 0.04 pH; ±0.5°C	± 2 mV; ±0.5°C
Precisión del dispositivo	0.1 pH, ±1°C	10 mV; ±1°C
Fuente de alimentación	220-240 Vac 50-60 Hz	
Aislamiento clase	II	
Consumo	10 W	
Caudal de la bomba	1,5 l/h	
Contrapresión máx.	1,5 bares	
Calibración de la sonda	Automática	
Estado de la bomba	Dosificación proporcional	
Tubo peristáltico (DI x DE mm)	Santoprene 6 x 9 mm	
Dimensiones (H x L x A):	224 x 165 x 126 mm	
Peso	3.0 kg	

(Nota: la medición de pH se compensa con temperatura a 25 °C; rango de medición de temperatura: 0...+55°C)

5. INSTRUCCIONES DE CONFIGURACIÓN DEL SISTEMA POOLDOSE

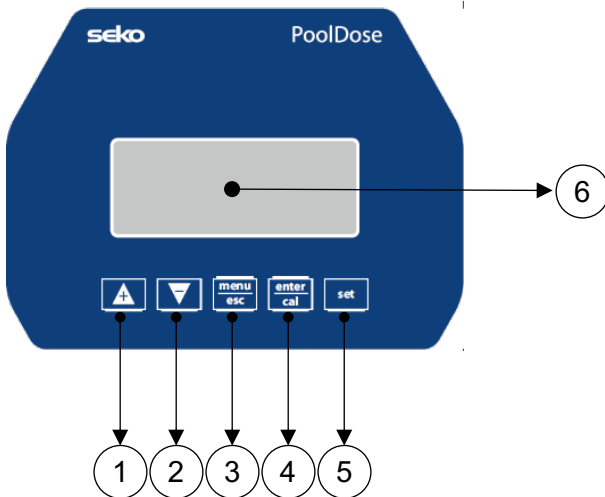

- 1) Botón para aumentar el valor
- 2) Botón para reducir el valor
- 3) Botón Menú/Esc
- 4) Botón Cal/OK
- 5) Botón para configurar el punto de ajuste
- 6) Pantalla digital

Configuración del programa – Pulse **menu/esc** durante 5 segundos

En la entrada de cada elemento del menú, el parámetro puede ser modificado directamente utilizando las teclas de flecha (**▲** y **▼**).

Para confirmar el ajuste actual y pasar al siguiente elemento, pulse el botón **enter/cal**.

El menú tiene una estructura circular: una vez en el último elemento, la confirmación del parámetro configurado se realiza pulsando **enter/cal**, y provoca el regreso al primer elemento del menú.



- 1 LANGUAGE (IDIOMA) – Se puede seleccionar entre 5 idiomas disponibles: **EN, FR, IT, DE, ES**
- 2 SETPOINT (PUNTO DE AJUSTE)– **7,4 pH** (5-9 pH) / **700 mV** (300-900 mV)
- 3 TIPO_DOSIFICACION – **Ácido** (Ácido/Alka) / **Bajo** (Bajo/Alto)
- 4 TIEMPO_ON= 30 segundos (rango desde 1 a 360 segundos) * Solo dosificación programada
- 5 TIEMPO_OFF= 60 segundos (rango desde 1 a 360 segundos)

4 MENU AVANZADO



- 4.1 SELECCIONAR MEDIDA – (pH/ORP)
- 4.2 BOMBA DE CIRCULACION – (Activada/desactivada)
- 4.3 COMPENSACION DE TEMPERATURA – (Auto/Manual 25°C, **rango 15...45°C**)
- 4.4 CALIBRACION Sonda TEMP. – Referencia (sensor PT100) o desactivada
- 4.5 OFA_OFF – (0-60 min)
- 4.6 ENTRADA CAUDAL
 - Impulso/litro 1:1
 - Unidad de medida m³, l.
- 4.7 CALIBRACION
 - Dos puntos
 - Un punto
 - Referencia
- 4.8 DOSIFICACION DE LA BOMBA PERISTALTICA
 - On/Off
 - Programada
 - Proporcional
 - Apagada
- 4.9 RELE AUX (Off/On)

PoolDose | pH · ORP





Guardar y salir de la configuración del programa – Pulse 

Al pulsar la tecla  se sale del menú de programación y se guardan los parámetros si el parámetro del elemento del menú en el que se encuentra no ha cambiado al pulsar la tecla .



Configuración del punto de ajuste

Pulse el botón  durante 3 segundos, use  y  para ajustar el valor deseado.

Stand-by (Modo suspensión)

Pulse los botones  y  al mismo tiempo durante 5 segundos para apagar la retroiluminación de la unidad. El sistema de dosificación y calibración están deshabilitados. Para salir del modo Stand-by (Suspensión), pulse los botones  y  al mismo tiempo.

Cebado

Mientras la bomba se encuentra en estado de Stand-by (Suspensión) pulse  y  al mismo tiempo.





Reinicio del contador de caudal

Para reiniciar el valor del "Totalizador Permanente", pulse el botón  durante 3 segundos, solo en modo suspensión.

Reinicio OFA

Pulse  para un clic y restablezca el valor de la cuenta regresiva.

Compensación/Menú de inclinación

Al pulsar los botones  y , la unidad muestra el valor de calibración de la compensación/inclinación. Pulse  o  para desplazarse por el menú.

Nota: Menú de configuración del tiempo de espera, después de 120 segundos sin acción, el controlador se escapa sin guardar los parámetros.

Ejemplo de pantalla:

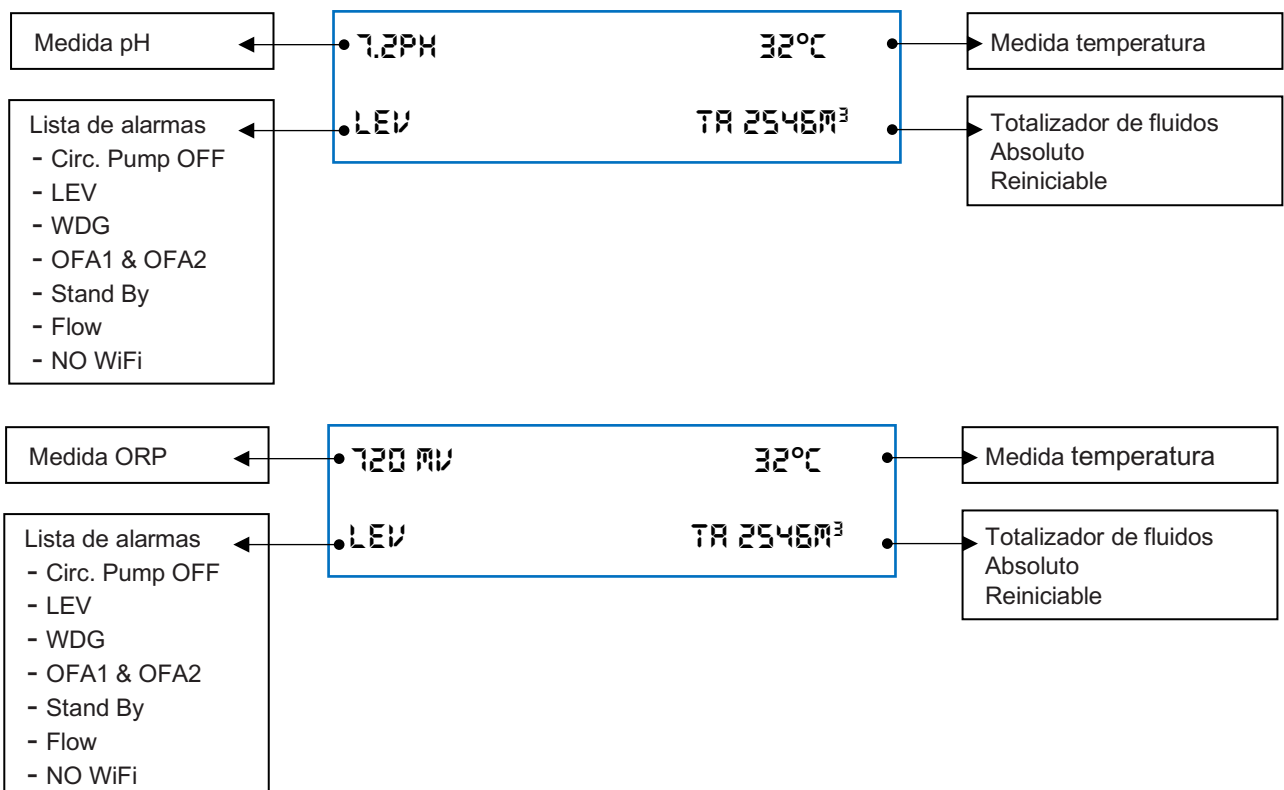

6. WEB SERVER INTERNO

Descargar la aplicación **SekoLink**

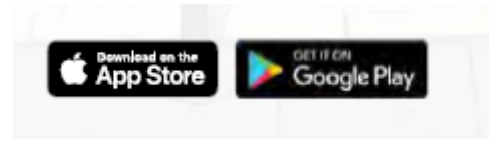

Registre su cuenta

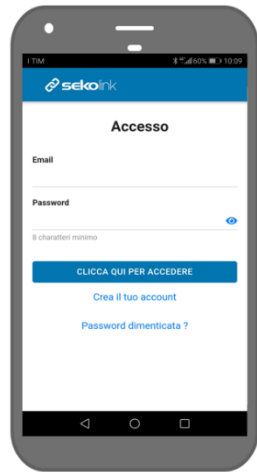

Con el QrCode, acceder en las páginas web internas
Establecer:

User name= ADMIN
Password= 0000



Configurar su conexión Wi-Fi LAN Nombre y Contraseña y confirmar



Complete el registro del su dispositivo

PoolDose | pH · ORP

Gracias a su registro, es posible utilizar **sekolink** y **sekoweb** de forma gratuita.



sekolink

Gracias a **sekolink** es posible gestionar su piscina:

- Seguimiento con gestión limitada
- Aplicación para smartphone compatible con iPhone o Android
- Para usuarios finales













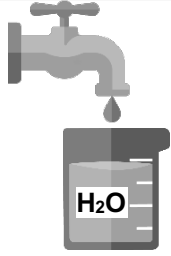

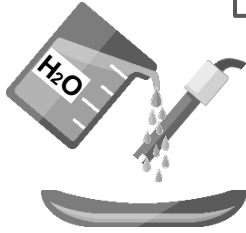
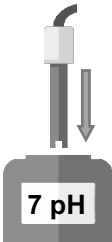
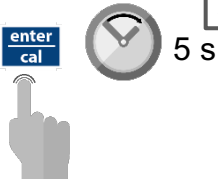
sekoweb

Utilice la dirección de **sekoweb** www.sekoweb.com o la aplicación para gestionar sus piscinas con un portal web profesional:

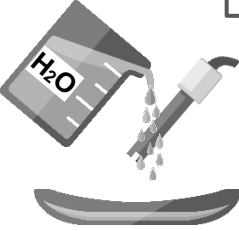
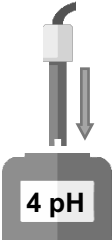
- Seguimiento con gestión completa
- Portal de Internet accesible mediante inicio de sesión en línea o escaneando el código QR de un producto
- Para instaladores, técnicos e ingenieros de piscinas y spa

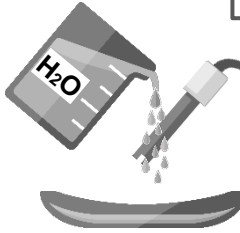

7. CALIBRACIÓN DEL pH

 <p>1</p>	 <p>2</p>	 <p>3</p>	 <p>4</p>
 <p>5 s</p> <p>Ajustar la calibración de pH</p>	 <p>6</p> <p>Calibración pH 7</p>	 <p>7</p> <p>60 s</p>	 <p>8</p>
 <p>9</p>	 <p>10</p>	 <p>11</p> <p>Calibración del pH 4</p>	 <p>12</p> <p>60 s</p>
 <p>13</p>	 <p>14</p>	 <p>15</p>	 <p>16</p> <p>Guardar y salir</p>

Nota: Si ha seleccionado “1 punto cal.”, la calibración se realizará solo en 1 punto utilizando la solución tampón de 7 pH.

Calibración de referencia

<p>Referencia CAL 7.2 pH</p> <p>La unidad parpadeará un valor de temperatura Establecer el valor de temperatura medido con el instrumento Ex. 7.4 pH</p>	<p>Referencia CAL 7.4 pH</p> 
--	--

8. CALIBRACIÓN DEL ORP

1

2

3

4

5

6

7

8

9

10

11

9. CALIBRACION DE LA TEMPERATURA

<p>Referencia CAL 26°C</p> <p>La unidad parpadeará un valor de temperatura Establecer el valor de temperatura medido con el instrumento Ex. 27°C</p>	<p>Referencia CAL 27°C</p> <p>enter cal</p>
---	---

10. DOSIFICACIÓN PROPORCIONAL

Punto de ajuste = 7,4 pH

Modo de dosificación = ácido

Banda proporcional: 1,5 pH (valor no modificable)

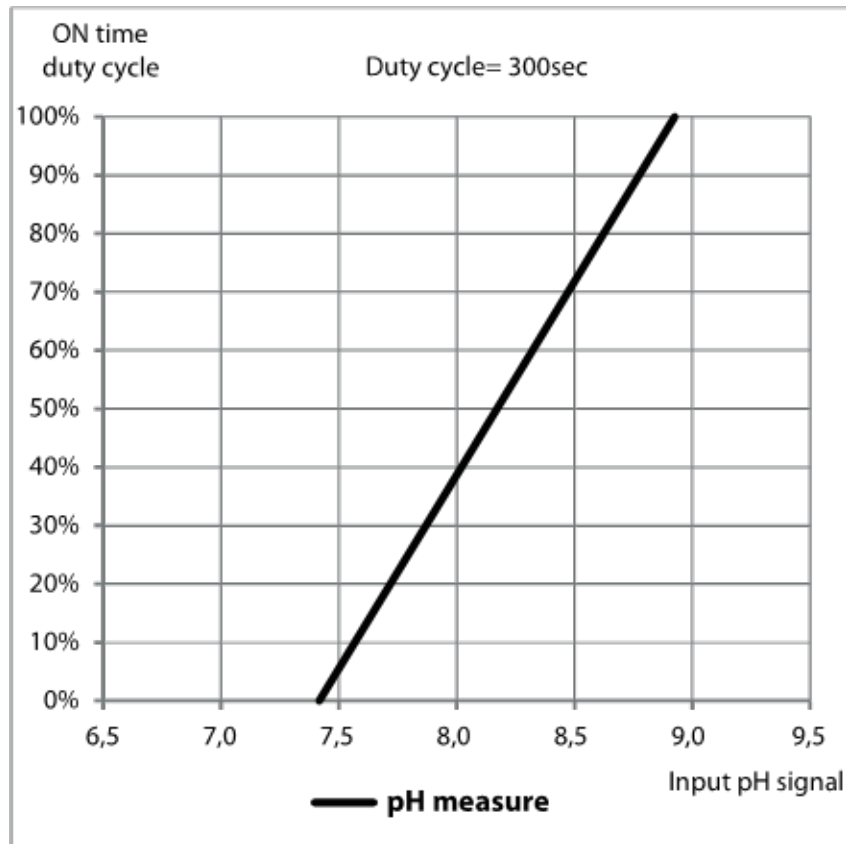



Punto de ajuste = 700 mV

Modo de dosificación = Bajo

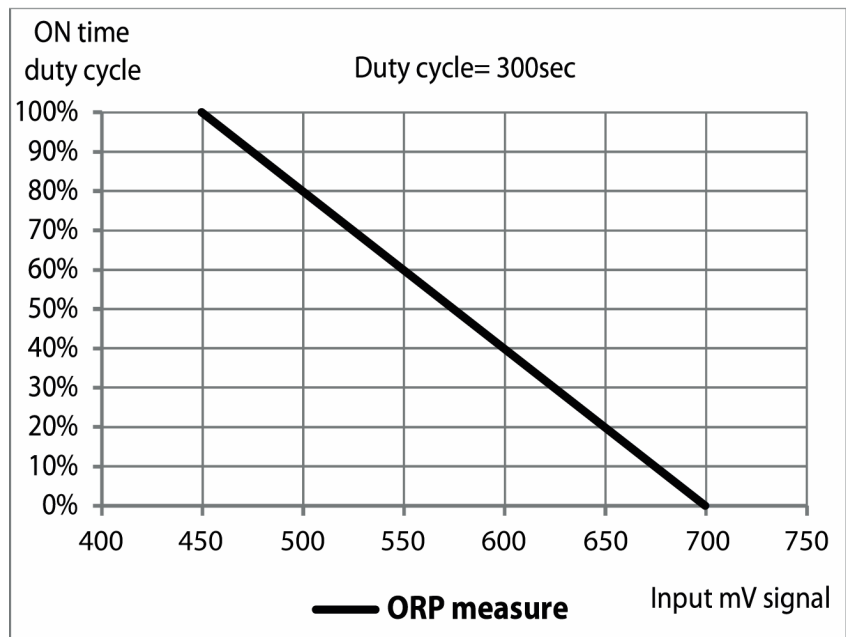



Banda proporcional: 250 mV (valor no modificable)



11. ALARMAS

Alarma	Pantalla pH PoolDose	Pantalla ORP PoolDose	Acciones que deben realizarse
Nivel	NIVEL DE DEPOSITO BAJO	-	- Restablezca el depósito de producto
Medida fuera de rango	MEDIDA MUY BAJA (<5 pH) MEDIDA MUY ELEVADA (>9 pH)	MEDIDA MUY BAJA (<600 mV) MEDIDA MUY ELEVADA (>800 mV)	- Sustituya o compruebe la sonda de medición - Restablezca la medida de pH / ORP
Alarma OFA (tiempo > tiempo OFA)	OFA	-	- Pulse  para reiniciar
Caudal	FILTRACION APAGADA	-	- Restablezca el caudal
Función de calibración	ERROR_____7_PH ERROR_____4_PH CALIBRAC._____PH7	ERROR_____700_MV	- Restaure la sonda o la solución tampón y repita el procedimiento de calibración
Error del sistema	ERROR DE PARAMETROS		- Pulse  para restablecer el parámetro por defecto - Unidad rota
Error Modbus	CONTR.		- Pulse  para reiniciar - Restablezca la comunicación

Para restaurar los parámetros por defecto, siga los siguientes pasos:

- Apague la unidad PoolDose
- Mantenga  y  pulsados y encienda la unidad
- La unidad parpadeará INIT.DEFAULT__NO
- Pulse  INIT.DEFAULT__YES
- Pulse  para restablecer los parámetros por defecto

Parámetros por defecto	PoolDose pH	PoolDose ORP
Idioma	EN	
Tiempo OFA	OFF	
Entrada de flujo	OFF	
Valor del punto de ajuste	7,4 pH	700 mV
Calibración	7 pH / 4 pH (2-puntos)	465 mV
Método de dosificación	Ácido	Bajo

Medida de alarma:

n	Item	Limites
1	Medida Temp. min	+10°C
2	Medida Temp. Max	+38°C
3	Medida pH min	6 pH
4	Medida pH Max	8 pH
5	Medida ORP min	+600 mV
6	Medida ORP Max	+800 mV

12. MANIPULACIÓN

Sustitución de la manguera:

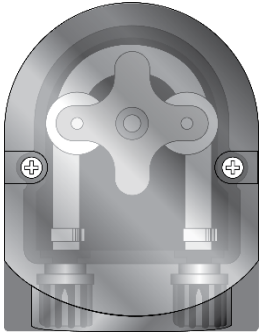

Abra la tapa de la bomba y suelte la manguera tirando del conector izquierdo hacia arriba.

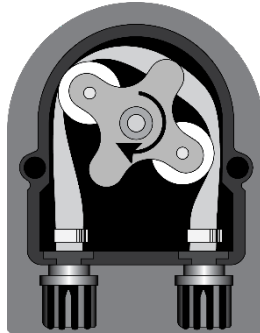

Coloque el rollo a las 7h 05, girándolo en la dirección de la flecha circular.

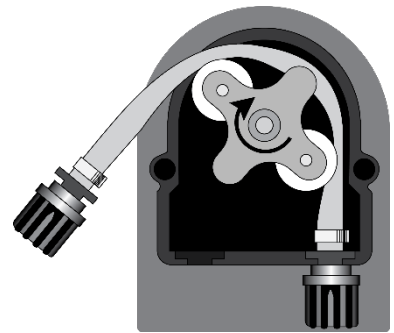

Suelte por completo el conector izquierdo, manteniéndola tensa hacia fuera, y gire el rollo en la dirección de la flecha circular para que la manguera quede liberada hasta el conector derecho.

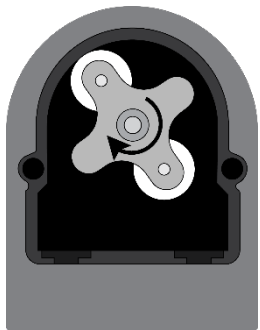

Coloque el rollo a las 7h 05 girándolo en la dirección de la flecha circular.

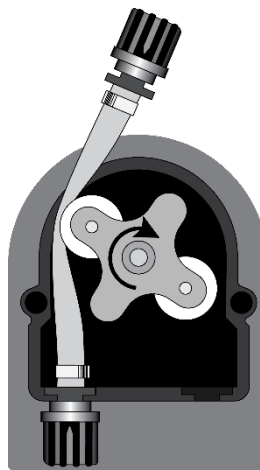

Introduzca el conector izquierdo en el compartimento correspondiente y pase la manguera por debajo de la guía del rollo. Gire el rollo en la dirección de la flecha circular, acompañando al mismo tiempo la manguera dentro del cabezal de la bomba hasta alcanzar el conector derecho.

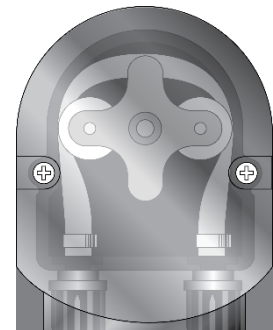

Cierre la tapa de la bomba y presione la superficie fuertemente para que quede correctamente encajada en su sitio.

PoolDose | pH · ORP

Conexiones de cables:

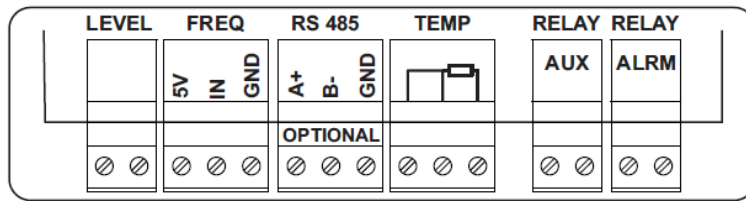

Item	Descripción	Bloque de terminales
Entrada de nivel:	Entrada sonda de nivel para tanque químico	
Entrada de frecuencia:	Entrada de señal de frecuencia para medidor de agua: A: medidor de agua mecánico con sensor Reed B: medidor de agua Padwheel con sensor Hall	
Puerto serial	No está presente , la función opcional	No está presente
Entrada del sensor de temperatura:	Entrada sensor de temperatura con dos o tres cables: A: sonda de temperatura con dos cables B: sonda de temperatura con tres cables	
Salida de relé auxiliar	Relé de contacto seco para dispositivo externo adicional	
Salida de relé de alarma	Relé de contacto seco para Alarma remota	



MISE EN GARDE !

Avant TOUTE intervention à l'intérieur du panneau de commande de l'appareil PoolDose, s'assurer de le débrancher de l'alimentation électrique.

Le non-respect des instructions contenues dans ce manuel peut entraîner des blessures aux personnes et/ou endommager l'appareil et le système.

1. CONTENU DE L'EMBALLAGE

 <p>A: Sellette de raccordement pour la fixation de PSS3 sur le tuyau 2" (φ=50 mm)</p>	 <p>B: Filtre au pied (Rehausse PP)</p>	 <p>C: Kit support de montage (φ=vis de 6 mm)</p>	 <p>D: Vanne à lèvres FPM (3/8" GAS)</p>	 <p>E: Porte-sonde PSS3 (1/2" GAS)</p>
 <p>F: Sonde pH</p>	 <p>G: Sonde Redox</p>	 <p>H: Solution tampon pH 7</p>	 <p>I: Solution tampon pH 4</p>	 <p>J: Solution d'étalonnage 465 mV</p>
 <p>K: Eau</p>	 <p>L: Tube de PVC 4x6 (IDxOD mm) (4m)</p>	 <p>M: Tube de PE 4x6 (IDxOD mm) (5m)</p>	 <p>N: Réducteur pour soupape d'injection (1/2" M vers 3/8" F)</p>	 <p>O: Sonde de température (1/2" M)</p>

Élément *	A	B	C	D	E	F	G	H	I	J	K	L	M	N	O
PoolDose pH	2 ^(*1)	1	1	1	1	1	-	1	1	-	1	1	1	1	1 ^(*2)
PoolDose ORP	2 ^(*1)	1	1	1	1	-	1	-	-	1	1	1	1	1	1 ^(*2)

* Les valeurs du tableau représentent le nombre d'éléments contenus à l'intérieur du paquet.

(*1 Trois pièces uniquement pour le modèle WiFi)

(*2 Une pièce uniquement pour le modèle WiFi)

PoolDose | pH · ORP

MISE EN GARDE !

Ces produits sont **DANGEREUX** et requièrent des précautions particulières lors de leur utilisation, leur manipulation et leur stockage.

- **NE JAMAIS mélanger les produits chimiques.**
- **NE JAMAIS** laisser des enfants ou des personnes qui n'ont pas lu ce manuel, utiliser ou manipuler PoolDose ou l'un de ses composants périphériques (y compris les produits chimiques).

Produits chimiques concernant le pH :

- **ABSOLUMENT** non recommandé => acide sulfurique pur
- Recommandé pour abaisser le pH => pH négatif (avec une base d'acide sulfurique)
- Recommandé pour élever le pH => pH positif (carbonate ou bicarbonate de sodium)

Produits chimiques concernant l'ORP

- **ABSOLUMENT** non recommandé => tous les types de chlore organique

Les sondes pH/ORP sont sujettes à l'usure et ne sont donc pas couvertes par la garantie.

2. INSTRUCTIONS D'INSTALLATION

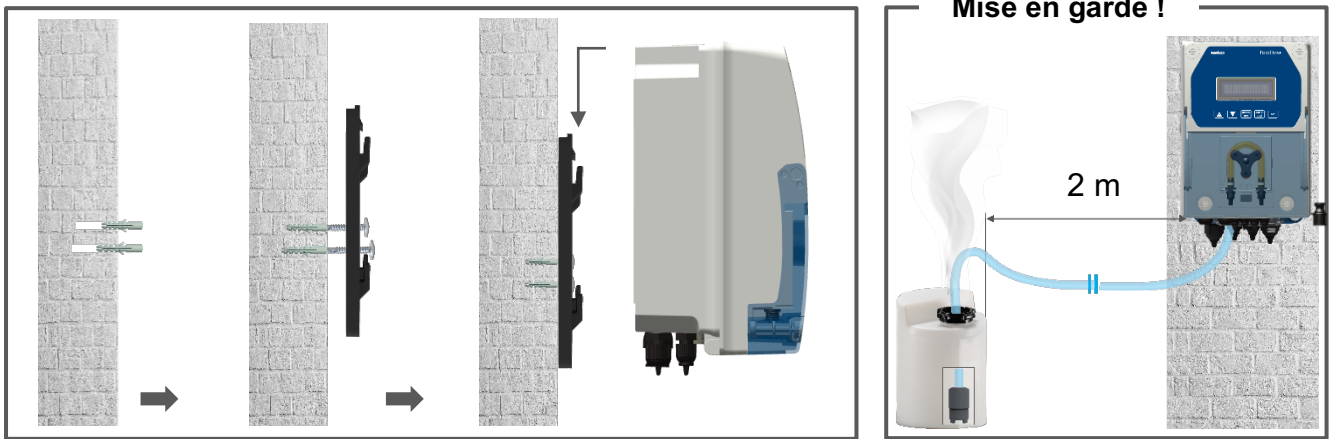

Assurez-vous que la pression d'injection est inférieure à 1,5 bar

Positionnement de la sonde

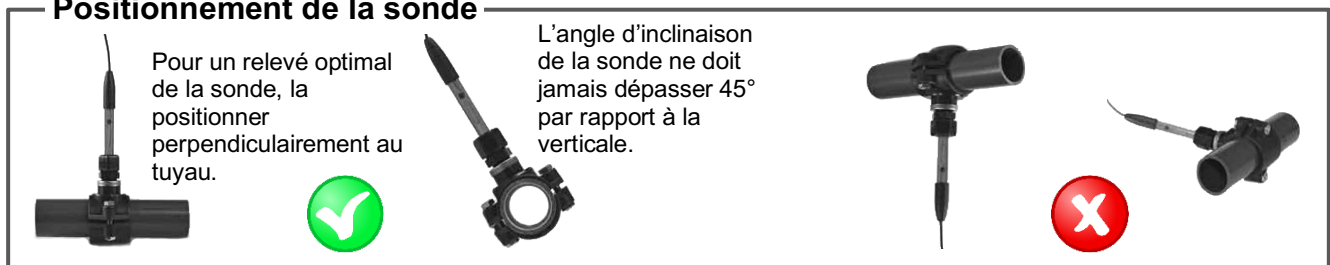

Unité d'installation

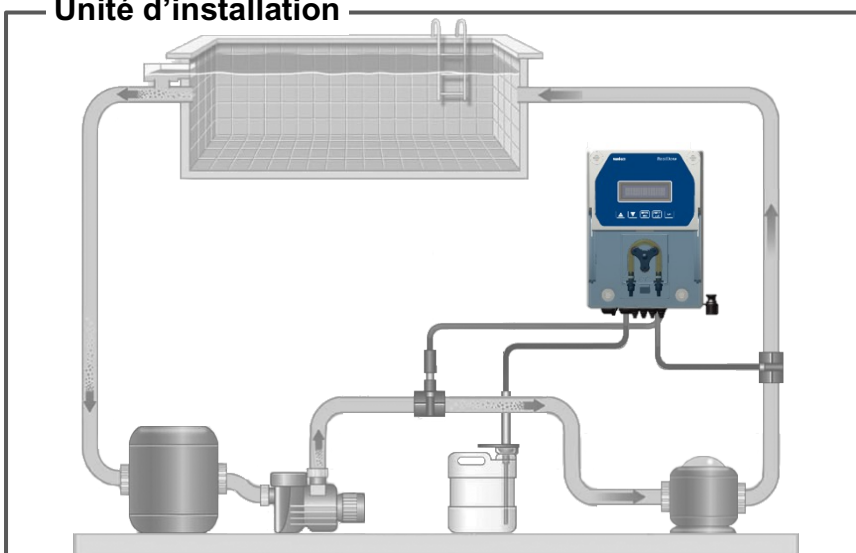

Mise en garde !

Utilisation avec l'électrolyseur au sel :

Pour les systèmes de pH, pour éviter le risque de dysfonctionnement ou d'endommagement, respecter les instructions suivantes :

1. Placer la sonde de mesure du pH en amont de la cellule de l'électrolyseur.
2. Pour éliminer les courants de Foucault, brancher l'eau de la piscine sur un point de masse électrique.
3. Placer le point d'injection du produit en aval de la cellule de l'électrolyseur.

3. RACCORDEMENTS ELECTRIQUES

Brancher l'alimentation électrique sur le secteur et le câble pré-câblé de servocommande au contact auxiliaire du boîtier de filtre (230 Vca).



Schéma de câblage :

1. Entrée sonde de niveau (réservoir de produit)
2. Signal de fréquence d'entrée par émetteur d'impulsions de compteur d'eau
3. Port série RS485 (en option)
4. Entrée sonde de température (capteur PT100 non inclus)
5. Sortie Relais pompe à distance (contact sec, relais 250 Vca 10 A)
6. Sortie Relais alarme à distance (contact sec, relais 250 Vca 10 A)

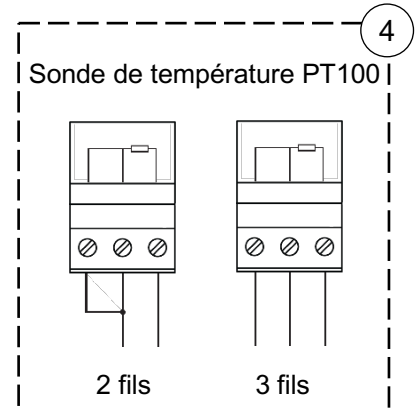
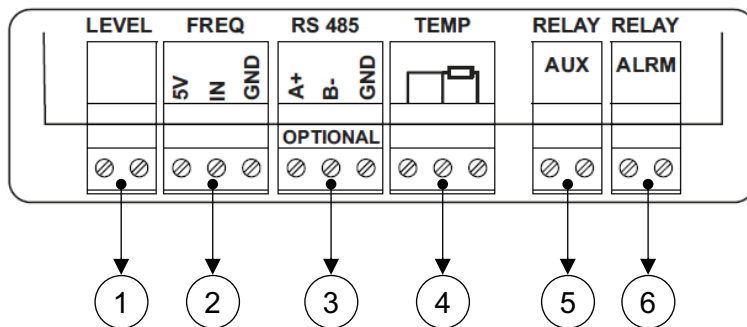
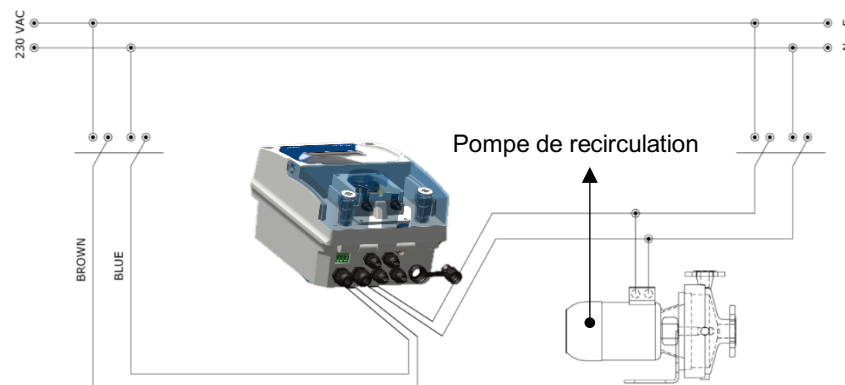

4. SPECIFICATIONS TECHNIQUES

Spécifications	PoolDose pH	PoolDose ORP
Plage de mesure	3.0 ÷ 10.0 pH; 0...+55°C	200 ÷ 999 mV, 0...+55°C
Plage de point de consigne	6.0 ÷ 8.0 pH	400 ÷ 850 mV
Plage d'alarme	6.0 ÷ 8.0 pH	600 ÷ 800 mV
Précision	± 0.04 pH; ±0.5°C	± 2 mV; ±0.5°C
Précision de l'appareil	0.1 pH, ±1°C	10 mV; ±1°C
Alimentation électrique	220-240 Vac 50-60 Hz	
Classe d'isolation	II	
Consommation	10 W	
Débit pompe	1,5 l/h	
Contre-pression max.	1,5 bar	
Étalonnage de sonde	Automatique	
État de la pompe	Dosage proportionnel	
Tuyau péristaltique (ID x OD mm)	Santoprene 6 x 9 mm	
Dimensions (H x W x D mm)	224 x 165 x 126 mm	
Poids	3.0 kg	

(Note: la mesure du pH est compensée en température à 25 °C; plage de mesure de la température: 0...+55°C)

5. INSTRUCTIONS DE CONFIGURATION SYSTEME POOLDOSE

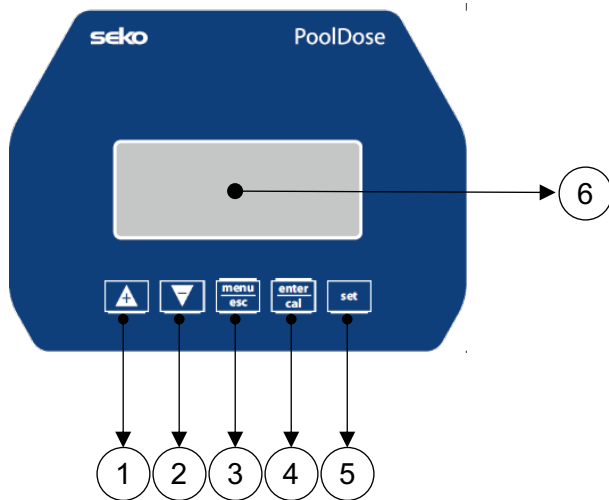

- 1) Bouton pour augmenter la valeur
- 2) Bouton pour diminuer la valeur
- 3) Bouton Menu/Échap
- 4) Bouton Étal/OK
- 5) Bouton pour configurer le point de consigne
- 6) Écran numérique

Configuration du programme – Appuyer sur **menu/esc** pendant 5 secondes

À l'entrée de chaque élément de menu, le paramètre peut être modifié directement à l'aide des touches fléchées (**▲** et **▼**).

Appuyer sur le bouton **enter/cal** pour confirmer le réglage actuel et passer au prochain élément.

Le menu a une structure circulaire : une fois arrivé au dernier élément, la confirmation du jeu de paramètres, en appuyant sur **enter/cal**, détermine le retour au premier élément de menu.

- 1 LANGUE – Il est possible de choisir parmi 5 langues disponibles : **EN**, FR, IT, DE, ES, RU
- 2 POINT DE CONSIGNE – **7,4 pH** (5-9 pH) / **700 mV** (300-900 mV)
- 3 TYPE_DOSAGE – **Acide** (Acid/Alka) / **Bas** (Bas/Haut)
- 4 TIME_ON = 30 secondes (plage de 1 à 360 secondes)
- 5 TIME_OFF = 60 secondes (plage de 1 à 360 secondes)



* Dosage temporisé uniquement

4 MENU AVANCE



- 4.1 SELECTIONNEZ MESURE – (pH/ORP)
- 4.2 POMPE DE RECIRCULATION – (Activée/Désactivée)
- 4.3 TEMP. COMPENSATION – (Auto/Manuel 25 °C)
- 4.4 ETALONNAGE SONDE DE TEMP. – Référence (capteur PT100) or Désactivée
- 4.5 OFR_OFF – (0-60 min)
- 4.6 D'ENTREE DEBIT
 - Impulsions/litre 1:1
 - Mesure unité m³, l.
- 4.7 ETALONNAGE
 - Deux points
 - Un point
 - Référence
- 4.8 TYPE DOSAGE PERISTALTIQUE
 - On/Off
 - Temporisé
 - Prop
 - Désactivé
- 4.9 RELAIS AUX (Off/On)

PoolDose | pH · ORP





Enregistrer et quitter la configuration du programme – Appuyer sur 

Une pression sur la touche  détermine la sortie du menu de programmation avec sauvegarde des paramètres, si le paramètre de l'élément de menu dans lequel on se trouve n'a pas été modifié en appuyant sur la touche .



Réglage du point de consigne

Appuyer sur le bouton  pendant 3 secondes, utiliser  et  pour régler la valeur souhaitée.

Veille

Appuyer simultanément sur les touches  et  pendant 5 secondes pour éteindre le rétroéclairage de l'appareil. Le dosage et l'étalonnage sont désactivés. Pour quitter le mode veille, appuyer simultanément sur les touches  et .

Amorçage

Pendant que la pompe est en veille, appuyer sur la touche  et  dans le même temps.





Réinitialisation du compteur de débit

Pour réinitialiser la valeur du « Totalisateur permanent », appuyer sur la touche  pendant 3 secondes, en mode veille uniquement.

Réinitialisation OFA

Appuyez sur  pendant un clic pour réinitialiser la valeur du compte à rebours.

Menu Offset/Pente

Appuyer sur les boutons  et  pour afficher la valeur d'étalonnage Offset/Pente de l'appareil, puis appuyer sur  ou  pour faire défiler le menu.

Note: Menu de réglage du délai d'attente, après 120 secondes sans action, le contrôleur s'échappe sans enregistrer les paramètres.

Exemple d'affichage:

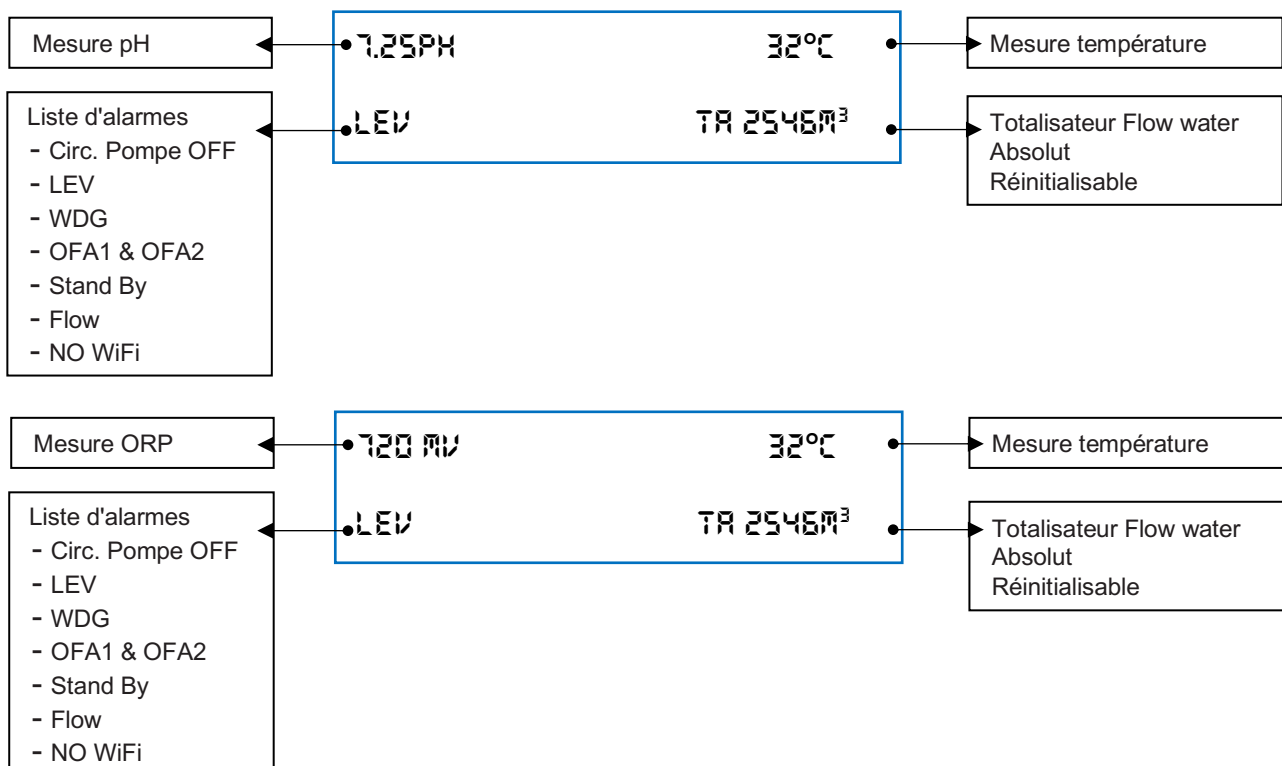

6. SERVEUR WEB INTERNE

Téléchargez l'application **SekoLink**



Enregistrer votre compte

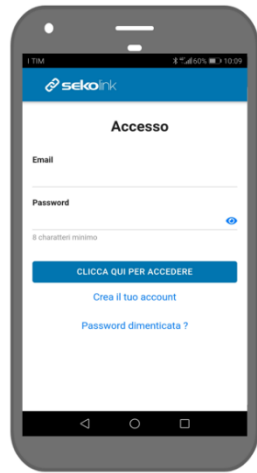

À l'aide du QR Code, connectez-vous aux pages Web internes
Définir :

Utilisateur= ADMIN
Password= 0000



Définissez le nom et le mot de passe de votre LAN WiFi et confirmez.



Terminez l'enregistrement de l'appareil

PoolDose | pH · ORP

Grâce à votre inscription, il est possible d'utiliser gratuitement **sekolink** et **sekoweb**.



sekolink

Grâce à **sekolink**, il est possible de gérer votre piscine::

- Suivi et gestion limitée
- Application pour smartphone compatible avec iPhone ou Android
- Pour les utilisateurs finaux













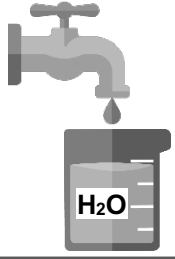

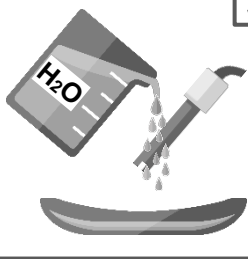
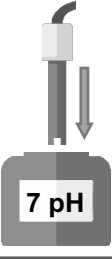
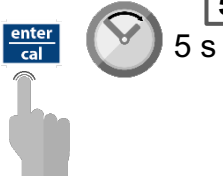
sekoweb

Utilisez l'adresse **sekoweb** www.sekoweb.com ou APP pour gérer vos piscines avec un portail web professionnel::

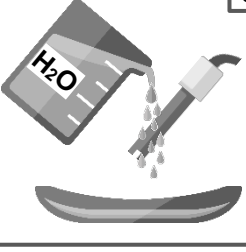
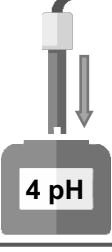
- Suivi et gestion complète
- Portail Internet accessible via une connexion en ligne ou en scannant le code QR d'un produit
- Pour les installateurs, techniciens et ingénieurs de piscines et de spas

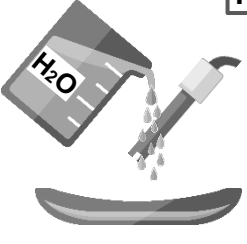
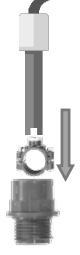

7. ÉTALONNAGE pH

 <p>1</p>	 <p>2</p>	 <p>3</p>	 <p>4</p>
 <p>5 s</p> <p>enter cal</p> <p>Définir étalonnage du pH</p>	 <p>enter cal</p> <p>Étalonnage 7 pH</p>	 <p>60 s</p>	 <p>7 pH Quality probe 100 %</p>
 <p>9</p>	 <p>4 pH</p>	 <p>enter cal</p> <p>Étalonnage 4 pH</p>	 <p>60 s</p>
 <p>4 pH Quality probe 100 %</p>	 <p>14</p>	 <p>15</p>	 <p>enter cal</p> <p>Enregistrer et quitter</p>

Note: Si vous avez sélectionné «1 point cal.», L'étalonnage sera effectué uniquement en 1 point en utilisant la solution tampon 7 pH.

Etalonnage de référence

<p>CAL Reference 7.2 pH</p> <p>L'unité fera clignoter une valeur de température Réglez la valeur de température mesurée avec l'instrument Ex. 7.4 pH</p>	<p>CAL Reference 7.4 pH</p> <p>enter cal</p> 
--	--

8. ÉTALONNAGE ORP

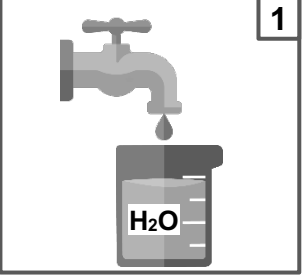
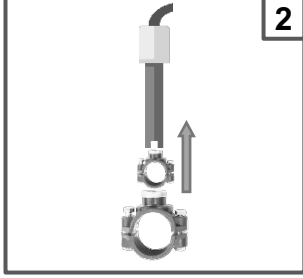
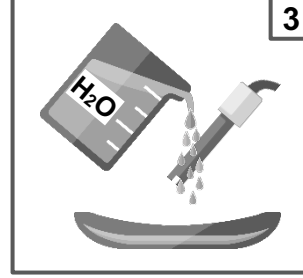
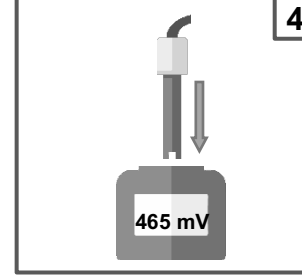
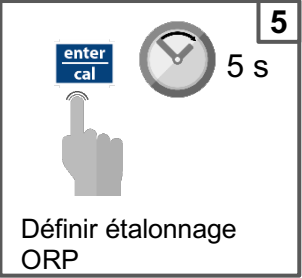
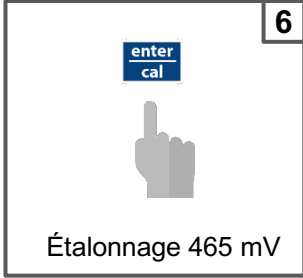
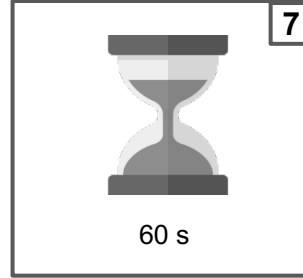
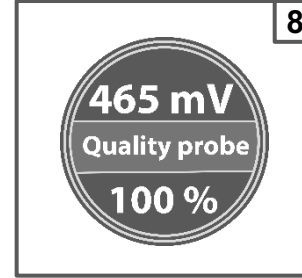
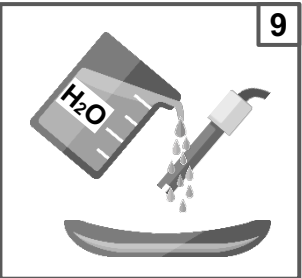
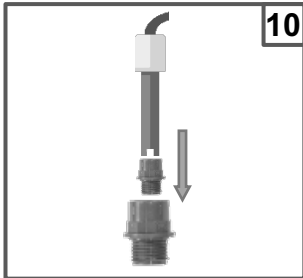
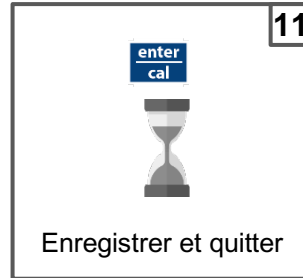
 <p>1</p>	 <p>2</p>	 <p>3</p>	 <p>4</p>
 <p>5</p> <p>Définir étalonnage ORP</p>	 <p>6</p> <p>Étalonnage 465 mV</p>	 <p>7</p> <p>60 s</p>	 <p>8</p>
 <p>9</p>	 <p>10</p>	 <p>11</p> <p>Enregistrer et quitter</p>	

9. ÉTALONNAGE DE LA TEMPÉRATURE

<p>CAL Reference 26°C</p> <p>L'unité fera clignoter une valeur de température Réglez la valeur de température mesurée avec l'instrument Ex. 27°C</p>	<p>CAL Reference 27°C</p> 
---	--

10. DOSAGE PROPORTIONNEL

Point de consigne = 7,4 pH

Mode de dosage = Acide

Bande proportionnelle: 1,5 pH (valeur non modifiable)

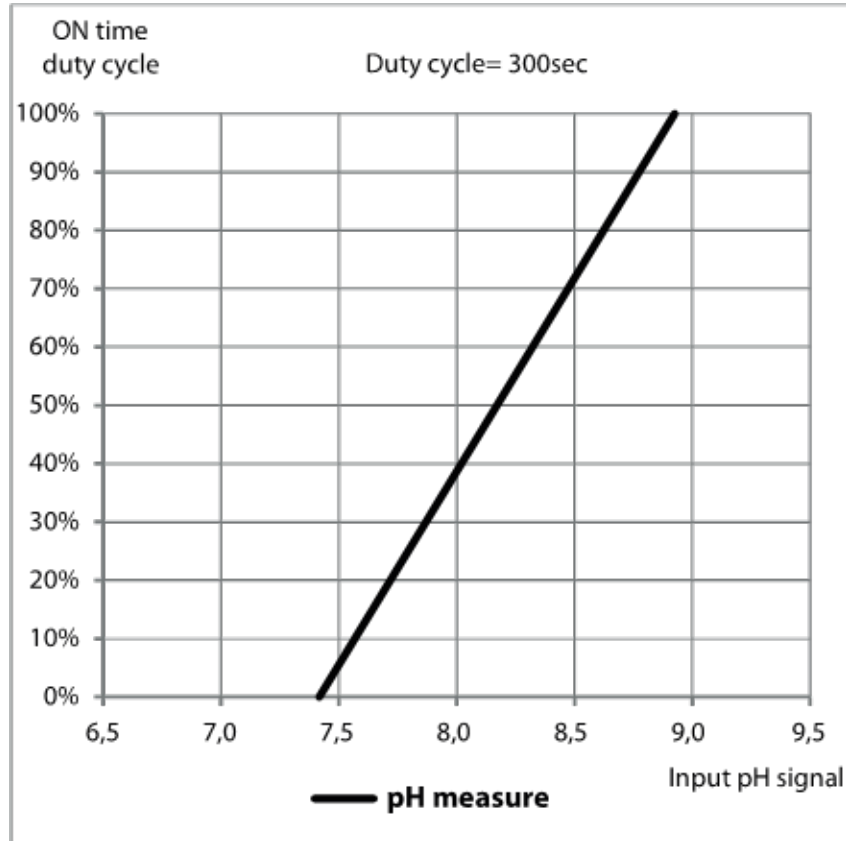



Point de consigne = 700 mV

Mode de dosage = Bas

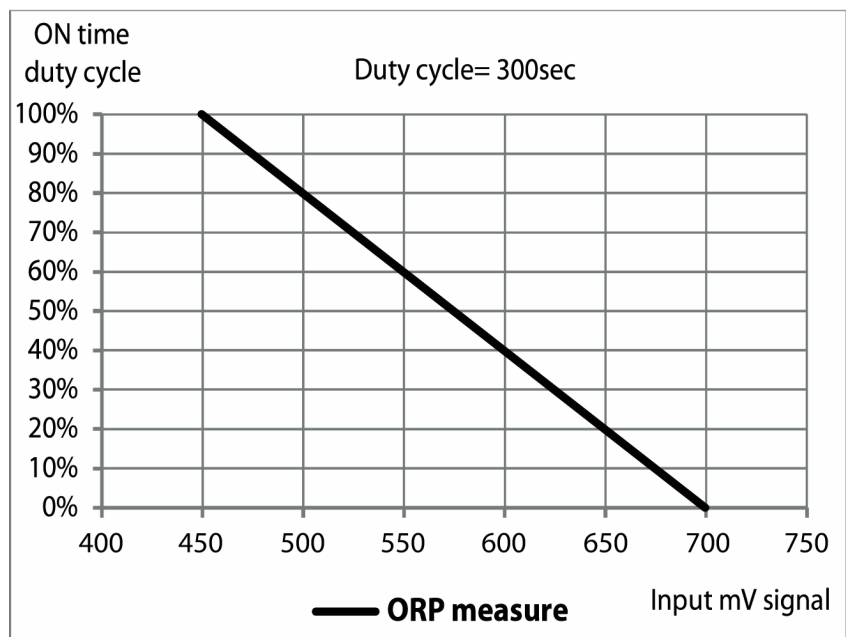



Bande proportionnelle= 250 mV (valeur non modifiable)



11. ALARMES

Alarme	Affichage PoolDose pH	Affichage PoolDose ORP	Actions à réaliser
Niveau	NIVEAU RESERVOIR BAS	-	- Ravitailler le réservoir de produit
Mesure hors plage	MESURE TROP BASS (<5 pH) MESURE TROP ELEVEE (>9 pH)	MESURE TROP BASS (<600 mV) MESURE TROP ELEVEE (>800 mV)	- Remplacer ou vérifier la sonde de mesure - Restaurer mesure pH/ORP
Alarme OFA (durée > durée OFA)	OFA	-	- Appuyer sur  pour réinitialiser
Débit	FILTRATION OFF	-	- Restaurer le débit
Fonction d'étalonnage	ERREUR_____7_PH ERREUR_____4_PH ETALONN_____PH7	ERREUR_____700_mV	- Restaurer la sonde ou la solution tampon et répéter la procédure d'étalonnage
Erreur système	ERREUR DE PARAMETRES		- Appuyer sur  pour restaurer le paramètre par défaut - Unité en panne
Erreur Modbus	MODS		- Appuyer sur  pour réinitialiser - Restaurer la communication

Pour restaurer les paramètres par défaut, suivre les étapes ci-dessous :

- Éteindre l'unité PoolDose
- Maintenir  et  enfoncés et allumer l'unité
- Le message INIT.DEFAULT__NO clignote à l'écran
- Appuyer sur  INIT.DEFAULT__YES
- Appuyer sur  pour restaurer les paramètres par défaut.

Paramètres par défaut	PoolDose pH	PoolDose ORP
Langue	EN	
Durée OFA	ARRÊT	
Admission de débit	ARRÊT	
Valeur de consigne	7,4 pH	700 mV
Étalonnage	7 pH / 4 pH (2 points)	465 mV
Méthode de dosage	Acide	Bas

Mesure d'alarme:

n	Item	Limites
1	Mesure Temp. min	+10°C
2	Mesure Temp. Max	+38°C
3	Mesure pH_min	6 pH
4	Mesure pH_Max	8 pH
5	Mesure ORP_min	+600 mV
6	Mesure ORP Max	+800 mV

12. MANUTENTION

Remplacement du tuyau :

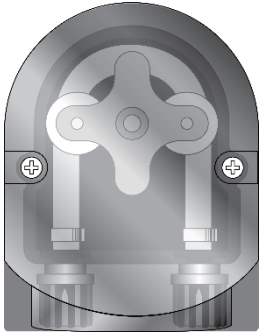

Ouvrir le couvercle de la pompe et libérer le tuyau en tirant sur le connecteur gauche vers le haut.

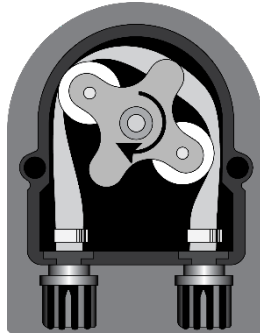

Placer le rouleau à 7h05, en le tournant dans le sens de la flèche circulaire.

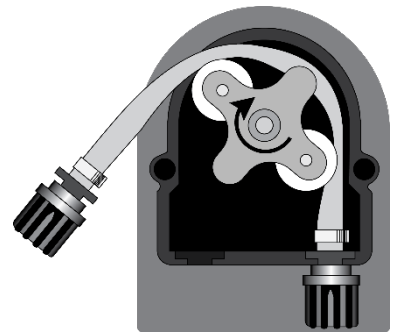

Libérer complètement le connecteur gauche, en le maintenant tendu vers l'extérieur, et tourner le rouleau dans le sens de la flèche circulaire de sorte que le tuyau soit libéré du connecteur droit.

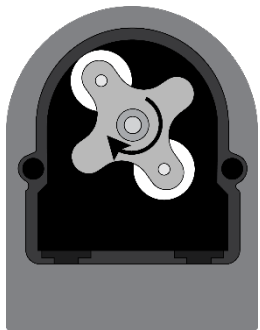

Placer le rouleau à 7h05, en le tournant dans le sens de la flèche circulaire.

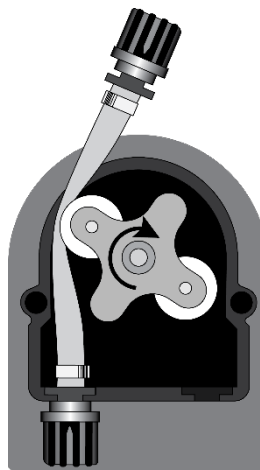

Insérer le connecteur gauche dans le boîtier correspondant et faire passer le tuyau sous le guide du rouleau. Tourner le rouleau dans le sens de la flèche circulaire, en accompagnant simultanément le tuyau dans la tête de la pompe, jusqu'à atteindre le connecteur droit.

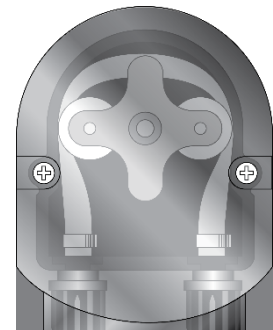



Fermer le couvercle de la pompe et appuyer fermement sur sa surface pour qu'elle soit correctement verrouillée en place.

PoolDose | pH · ORP

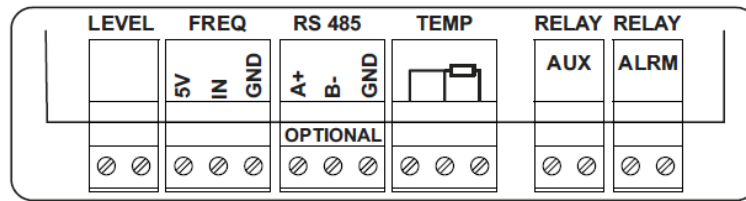
Connexions de fils:

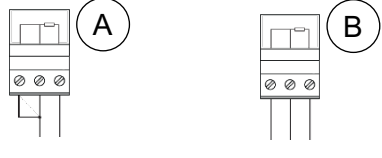
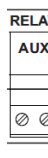
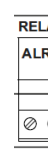

Item	Description	Bornier
Entrée de niveau:	Entrée de sonde de niveau pour réservoir de produits chimiques	
Entrée de fréquence:	Entrée de signal de fréquence pour compteur d'eau A: compteur d'eau mécanique avec capteur Reed B: compteur d'eau Padwheel avec capteur Hall	
Port série	Non présent , fonction optionnelle	Non présent
Entrée du capteur de température:	Entrée du capteur de température avec deux ou trois fils: A: sonde de température avec deux fils B: sonde de température avec trois fils	
Sortie relais Aux	Relais à contact sec pour appareil externe supplémentaire	
Sortie relais d'alarme	Relais à contact sec pour télécommande d'alarme	













AVVERTENZA!

Prima di effettuare **QUALSIASI** operazione all'interno del pannello di controllo del dispositivo PoolDose, assicurarsi di averlo scollegato dalla rete di alimentazione.

Il mancato rispetto delle istruzioni contenute nel presente manuale può causare lesioni a persone e/o danni al dispositivo e al sistema.

1. CONTENUTO DELLA CONFEZIONE

 A: Staffa per fissaggio del PSS3 sul tubo da 2" (φ=50 mm)	 B: Filtro di fondo (montante in PP)	 C: Kit staffe di montaggio (φviti da 6 mm)	 D: Valvola a labbro FPM (3/8" GAS)	 E: Porta sonda PSS3 (1/2" GAS)
 F: Sonda pH	 G: Sonda Redox	 H: Soluzione tampone pH 7	 I: Soluzione tampone pH 4	 J: Soluzione di calibrazione 465mV
 K: Acqua	 L: Tubo PVC 4x6 (IDxOD mm) (4m)	 M: Tubo PE 4x6 (IDxOD mm) (5m)	 N: Riduttore per valvola di iniezione (1/2" M - 3/8" F)	 O: Sonda di temperatura (1/2" M)

Componente*	A	B	C	D	E	F	G	H	I	J	K	L	M	N	O
Sistema															
PoolDose pH	2(*1)	1	1	1	1	1	-	1	1	-	1	1	1	1	1(*2)
PoolDose ORP	2(*1)	1	1	1	1	-	1	-	-	1	1	1	1	1	1(*2)

* I valori riportati nella tabella rappresentano il numero di componenti contenuti nella confezione.

(*1 Tre pezzi solo per il modello WiFi)

(*2 Un pezzo solo per il modello WiFi)

PoolDose | pH · ORP

AVVERTENZA!

Questi prodotti sono **PERICOLOSI** e richiedono precauzioni speciali durante l'uso, la manipolazione e lo stoccaggio.

- **Non miscelare MAI i prodotti chimici.**
- Non permettere MAI a bambini o a persone che non abbiano letto il presente manuale di utilizzare o manomettere PoolDose o i suoi componenti periferici (inclusi i prodotti chimici).

Prodotti chimici pH:

- **ASSOLUTAMENTE** sconsigliato => acido solforico puro
- Consigliato per abbassare il pH => pH negativo (con una base di acido solforico)
- Consigliato per aumentare il pH => pH positivo (carbonato o bicarbonato di sodio)

Prodotti chimici ORP:

- **ASSOLUTAMENTE** sconsigliato => tutti i tipi di cloro organico

Le sonde pH / ORP sono **sogette a usura e pertanto non sono coperte dalla garanzia.**

2. ISTRUZIONI PER L'INSTALLAZIONE

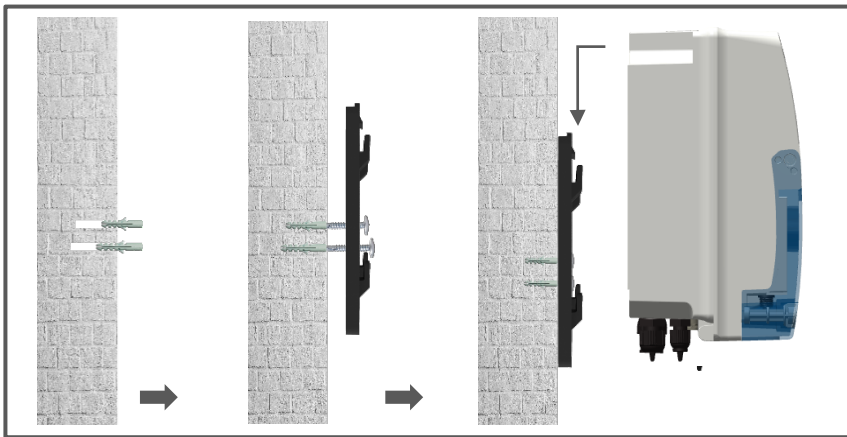

Verificare che la pressione di iniezione sia inferiore a 1,5 bar

Posizionamento della sonda

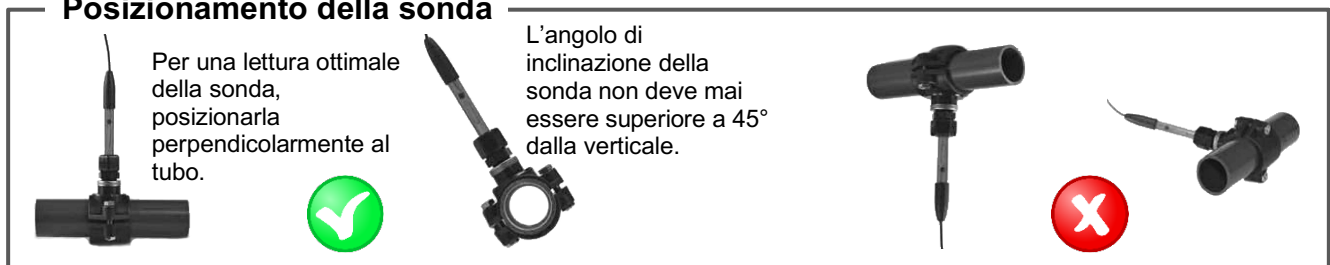

Impianto di installazione

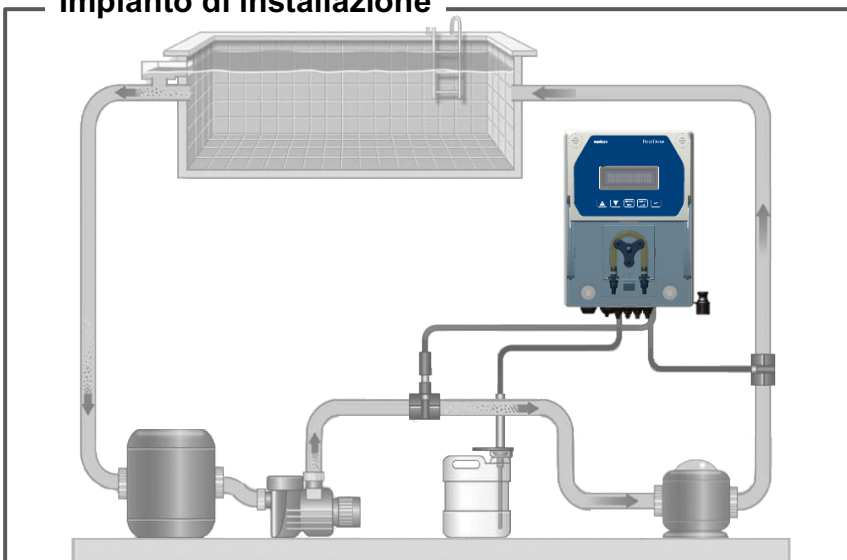

Avvertenza!

Usare con generatore di cloro a sale:

Per evitare rischi di malfunzionamento o danneggiamento dei sistemi pH, rispettare le istruzioni riportate di seguito:

1. Posizionare la sonda di misurazione del pH prima della cella del generatore di cloro.
2. Per eliminare le eventuali correnti parassite, collegare l'acqua della piscina a una massa elettrica.
3. Collocare il punto di iniezione del prodotto dopo la cella del generatore di cloro.

3. COLLEGAMENTI ELETTRICI

Collegare il cavo di alimentazione alla rete di alimentazione elettrica e il cavo pre-cablato del servocomando al contatto ausiliario della scatola dei filtri (230 Vca).

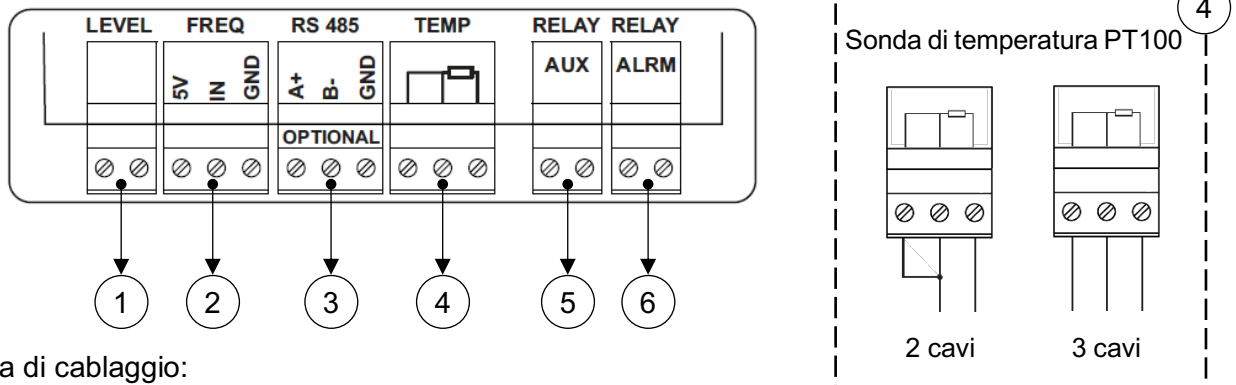

Schema di cablaggio:

1. Ingresso la sonda di livello (serbatoio prodotto)
2. Ingresso segnale di frequenza dal mittente di impulsi contatore dell'acqua
3. Porta seriale RS485 (**opzionale**)
4. Ingresso sonda di temperatura (Sonda di temperatura PT100 non inclusa)
5. Uscita relè pompa ausiliaria (contatto pulito, relè da 250 Vca 10 A)
6. Uscita allarme relè remoto (contatto pulito, relè da 250 Vca 10 A)

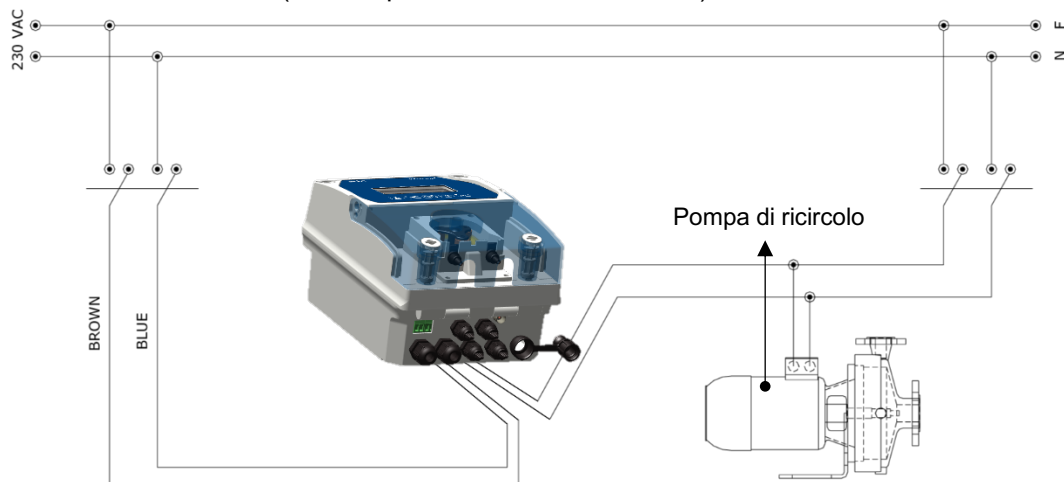

4. SPECIFICHE ELETTRICHE

Specifiche	PoolDose pH	PoolDose ORP
Intervallo misura	3.0 ÷ 10.0 pH; 0...+55°C	200 ÷ 999 mV, 0...+55°C
Intervallo setpoint	6.0 ÷ 8.0 pH	400 ÷ 850 mV
Intervallo allarme	6.0 ÷ 8.0 pH	600 ÷ 800 mV
Accuratezza	± 0.04 pH; ±0.5°C	± 2 mV; ±0.5°C
Accuratezza del dispositivo	0.1 pH, ±1°C	10 mV; ±1°C
Alimentazione	220-240 Vac 50-60 Hz	
Classe di isolamento	II	
Consumo	10 W	
Portata della pompa	1,5 l/h	
Contropressione max.	1,5 bar	
Calibrazione della sonda	Automatica	
Stato pompa	Dosaggio proporzionale	
Tubo peristaltico (DI x DE mm)	Santoprene 6 x 9 mm	
Dimensioni (H x W x D mm)	224 x 165 x 126 mm	
Peso	3.0 kg	

(Nota: la misura del pH è compensata in temperatura a 25 °C; range di misura della temperatura: 0...+55°C)

5. ISTRUZIONI DI CONFIGURAZIONE DEL SISTEMA POOLDOSE

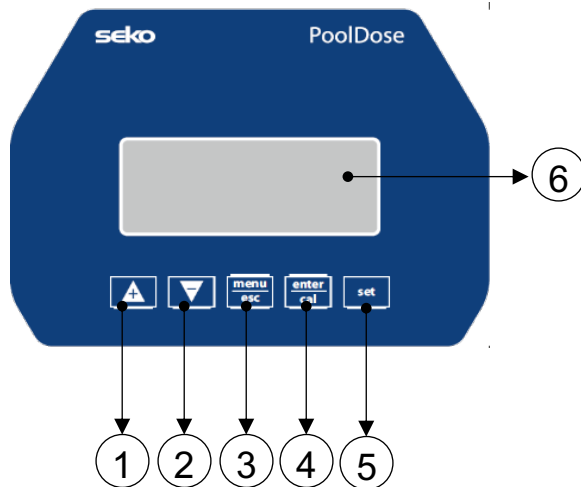

- 1) Pulsante per aumentare il valore
- 2) Pulsante per ridurre il valore
- 3) Pulsante Menu/Esc
- 4) Pulsante Cal/OK
- 5) Pulsante di impostazione del setpoint
- 6) Display digitale

Configurazione del programma - Premere **menu esc** per 5 secondi

Accedendo ad ogni voce del menu, è possibile modificare direttamente il parametro con i tasti freccia (**▲** e **▼**).

Per confermare dell'impostazione attuale e passare alla voce successiva, premere il tasto **enter cal**.

Il menu è dotato di una struttura circolare: una volta arrivati all'ultima voce, quando si conferma il parametro impostato, premendo **enter cal** si torna alla prima voce.

1 LINGUA - È possibile selezionare tra 5 lingue disponibili: **EN**, FR, IT, DE, ES

2 SETPOINT - **7,4 pH** (6-8pH) / **700 mV** (300-900 mV)

3 TIPO DOSSEGIO - **Acido** (Acido/Alcalino) / **Basso** (Basso/Alto)

* Solo dosaggio temporizzato

4 TIME_ON = (Tempo_avvio) 30 secondi (intervallo da 1 a 360 secondi)

5 TIME_OFF = (Tempo_arresto) 60 secondi (intervallo da 1 a 360 secondi)

4 MENU AVANZATO

4.1 FUNZIONE POMPA - (pH/ORP)

4.2 POMPA DI RICIRCOLO - (abilitata/disabilitata)

4.3 COMPENSAZIONE TEMP. - (Automatica/Manuale 25°C)

4.4 CALIBRAZIONE SONDRA TEMP. • Riferimento (sensore PT100) o disabilitata

4.5 OFR_OFF - (0-60 min.)

4.6 PORTATA IN INGRESSO

- Impulso/litri 1:1
- Unità di misura m³, l.

4.7 CALIBRAZIONE

- Due punti
- Punto unico
- Riferimento



4.8 TIPO DOSSEGIO PERISTALTICO

- On/Off
- A tempo
- Prop
- Off

4.9 RELE RUX (Off/On)

PoolDose | pH · ORP





Salva ed esci dalla configurazione del programma - Premere 

Premendo  si esce dal menu di programmazione salvando i parametri, a condizione che la voce del menu in cui ci si trova non sia stata modificata quando si è premuto il tasto .

Regolazione del setpoint

Tenere il pulsante  premuto per 3 secondi, usare  e  per impostare il valore desiderato.

Modalità Stand-by (retroilluminazione accesa)

Tenere i pulsanti  e  premuti simultaneamente per 5 secondi per disattivare la retroilluminazione dell'unità. Dosaggio e calibrazione sono disattivati. Per uscire dalla modalità di standby, premere simultaneamente i pulsanti  e .

Adescamento

Quando la pompa è in standby, premere contemporaneamente  e  per adescare la pompa.





Reinizializzazione del calcolatore di portata

Per reiniziare il valore del parametro "Permanent Totalizer" (Totalizzatore fisso) tenere premuto il tasto  per 3 secondi solo in modalità stand-by.

OFA reset

Premere il tasto  semplice pressione (click), reset del valore dell'allarme OFA.

Menu Offset/Slope (Offset/Pendenza)

Premere i pulsanti  e  per visualizzare sull'unità i valori di calibratura "Offset/Slope" (Offset/Pendenza); premere  o  per scorrere il menu.

Nota: menu di impostazione del timeout, dopo 120 secondi senza azione il controller esce da solo senza salvare i parametri

Esempio di visualizzazione:

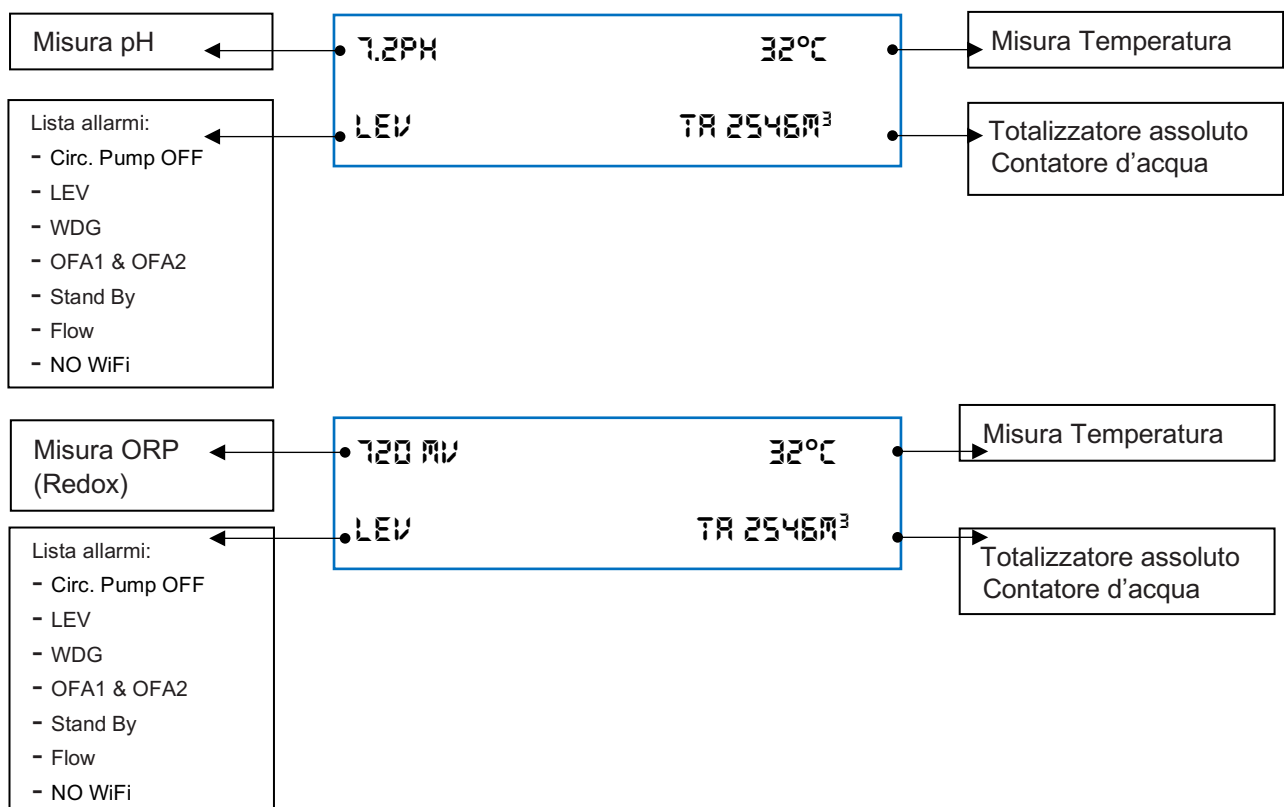

6. INTERNAL WEB SERVER

Scaricare l'applicazione **SekoLink**

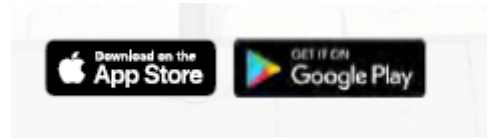

Registrare il tuo account

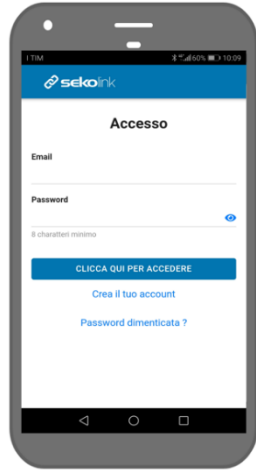

Grazie al Qr Code collegarsi alle pagine interne del prodotto
Impostare:

User name = ADMIN
Password= 0000



Impostare il nome della WiFi LAN e Password locale.



Completa la registrazione del prodotto in rete seguendo i passi della APP.

Grazie alla registrazione è possibile usare la APP **sekolink** e portale **sekoweb** gratuitamente.



sekolink

Grazie alla APP **sekolink** è possibile controllare la tua piscina:

- Monitoraggio con gestione limitata
- App per smartphone compatibile con iPhone o Android
- Per gli utenti finali









sekoweb

Use **sekoweb** address link www.sekoweb.com or APP to manage your pools with professional webportal:

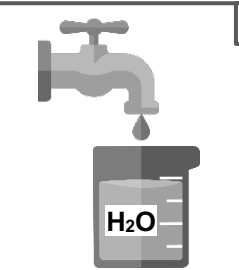
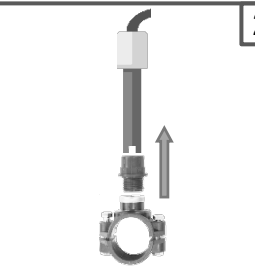
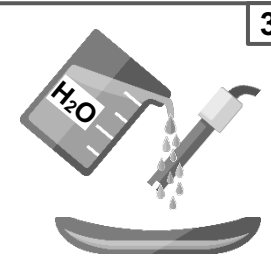
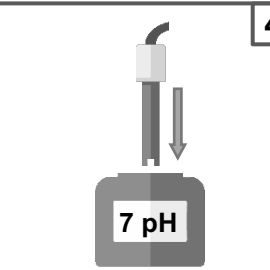
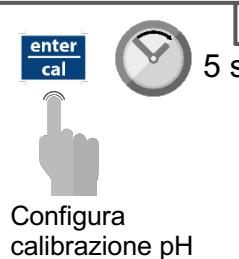
- Monitoraggio con gestione completa
- Portale Internet accessibile tramite login in linea o scansionando il codice QR di un prodotto
- Per installatori, tecnici e ingegneri di piscine e spa

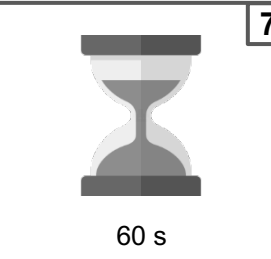
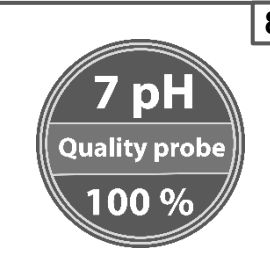
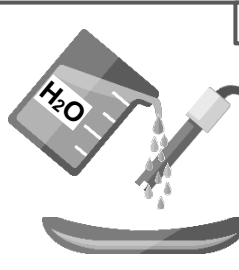
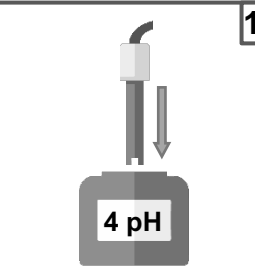
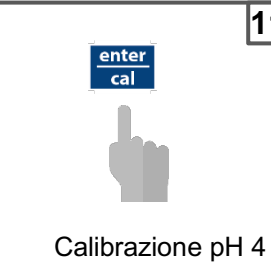
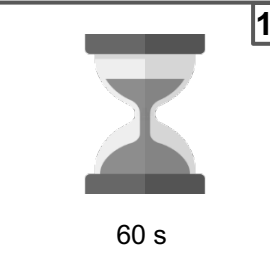

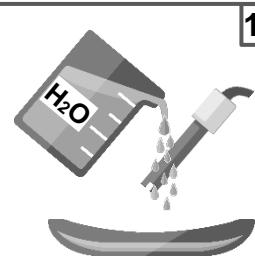
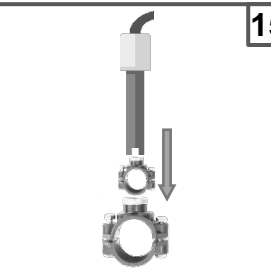
7. CALIBRAZIONE pH

 <p>1</p>	 <p>2</p>	 <p>3</p>	 <p>4</p>
 <p>5</p> <p>Configura calibrazione pH</p>	 <p>6</p> <p>Calibrazione pH 7</p>	 <p>7</p> <p>60 s</p>	 <p>8</p>
 <p>9</p>	 <p>10</p>	 <p>11</p> <p>Calibrazione pH 4</p>	 <p>12</p> <p>60 s</p>
 <p>13</p>	 <p>14</p>	 <p>15</p>	 <p>16</p> <p>Salva ed esci</p>

Reference calibration

CAL Reference
7.2 pH

The unit will flash a temperature value

Set the temperature value measured with the instrument

Ex. 7.4 pH

CAL Reference
7.4 pH



8. CALIBRAZIONE ORP

1

2

3

4

5

6

7

8

9

10

11

enter cal 5 s

enter cal

Calibrazione ORP

Calibrazione 465 mV

60 s

465 mV
Quality probe
100 %

enter cal

Salva ed esci

9. CALIBRAZIONE TEMPERATURA

CAL Reference
26°C

The unit will flash a temperature value

Set the temperature value measured with the instrument

Ex. 27°C

CAL Reference
27°C

enter cal

10. DOSAGGIO PROPORZIONALE

Setpoint= 7,4 pH

Modalità di dosaggio = Acido

Banda proporzionale= 1,5 pH (valore non modificabile)

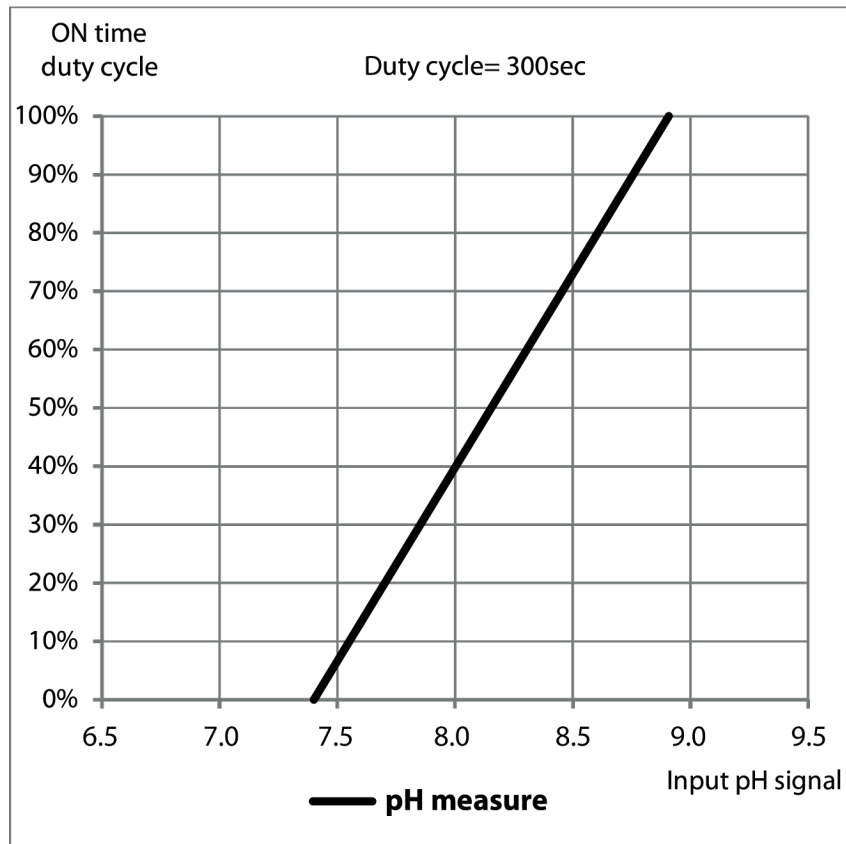



Setpoint = 700 mV

Modalità di dosaggio = Bassa

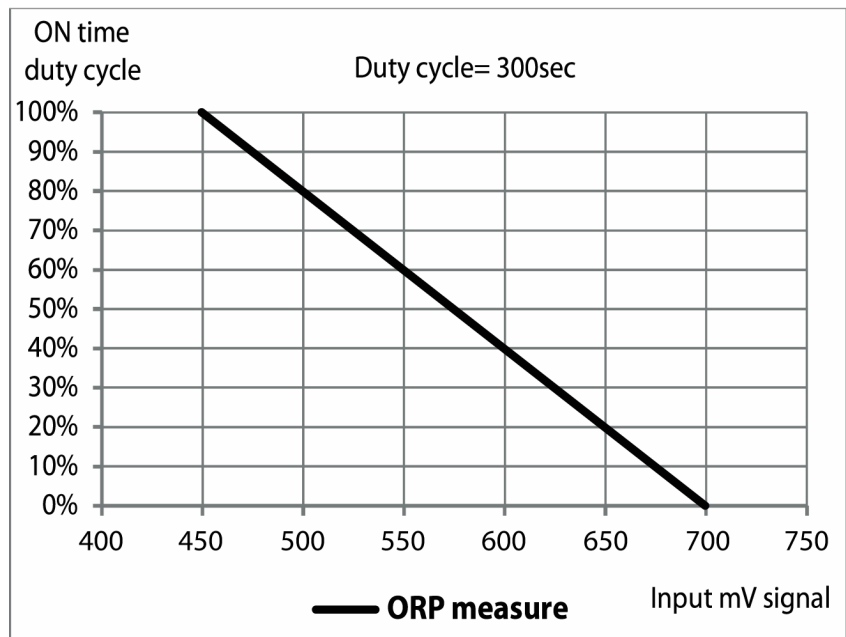



Banda Proporzionale= 250 mV (valore non modificabile)



11. ALLARMI

Allarme	Display PoolDose pH	Display PoolDose ORP	Azioni da eseguire
Livello	TANK LEVEL LOW	-	- Ripristinare il serbatoio prodotto
Misura fuori intervallo	MEASURE TOO LOW (<6 pH) MEASURE TOO HIGH (>8 pH)	MEASURE TOO LOW (<600 mV) MEASURE TOO HIGH (>800 mV)	- Sostituire o controllare la sonda di misura - Ripristinare la misura pH / ORP
Allarme OFA (tempo > tempo OFA)	OFA	-	- Premere  per azzerare
Portata	FILTRATION OFF	-	- Ripristinare la portata
Funzione di calibrazione	ERROR_____4_PH ERROR_____7_PH CALIBRAT_____PH7	ERROR_____700_MV	- Ripristinare la soluzione Sonda o Tampone e ripetere la procedura di calibrazione
Errore del sistema	ERRORE DEI PARAMETRI		- Premere  per ripristinare i parametri predefiniti - Unità danneggiata
Errore Modbus	MOD6		- Premere  per azzerare - Ripristinare la comunicazione

Per ripristinare i parametri predefiniti, procedere come indicato di seguito:

- Spegnerne l'unità PoolDose
- Tenere  e  premuti e collegare l'unità
- L'unità inizierà a lampeggiare INIT.DEFAULT__NO
- Premere  INIT.DEFAULT__YES
- Premere  per ripristinare i parametri predefiniti.

Parametri predefiniti	PoolDose pH	PoolDose ORP
Language (Lingua)	EN	
Time OFA (Tempo OFA)	OFF	
Flow Input (Ingresso flusso)	OFF	
Set Point value (Valore di setpoint)	7,4 pH	700 mV
Calibration (Calibrazione)	pH 7 / pH 4 (2 punti)	465 mV
Dosing Method (Metodo di dosaggio)	Acid (Acido)	Low (Basso)

Alarm measure:

n	Item	Limits
1	Temp. Measure min	+10°C
2	Temp. Measure Max	+38°C
3	pH Measure min	6 pH
4	pH Measure Max	8 pH
5	ORP Measure min	+600 mV
6	ORP Measure Max	+800 mV

12. MOVIMENTAZIONE

Sostituzione dei tubi:

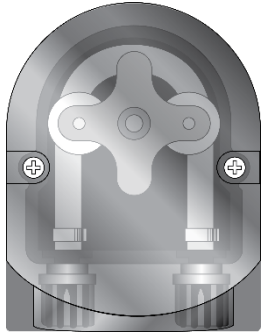

Aprire il coperchio della pompa e rilasciare il tubo tirando il connettore di sinistra verso l'alto.

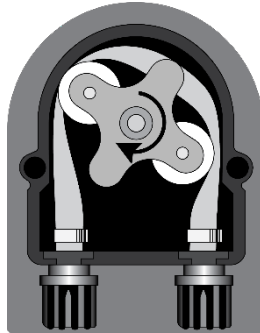

Posizionare il rullo alle ore 7:05, ruotandolo nella direzione della freccia circolare.

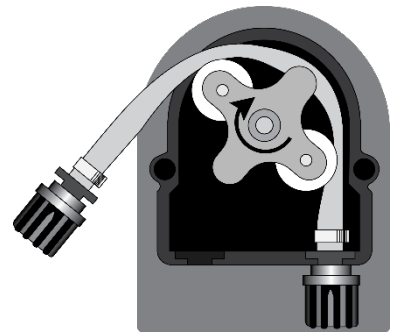

Rilasciare completamente il connettore di sinistra, tenendolo teso verso l'esterno, e ruotare il rullo nella direzione della freccia circolare in modo da liberare il tubo verso il connettore di destra.

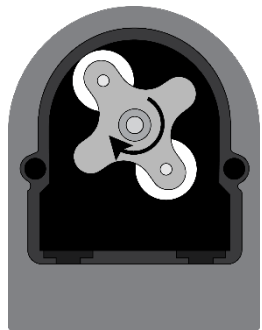

Posizionare il rullo alle ore 7:05, ruotandolo nella direzione della freccia circolare.

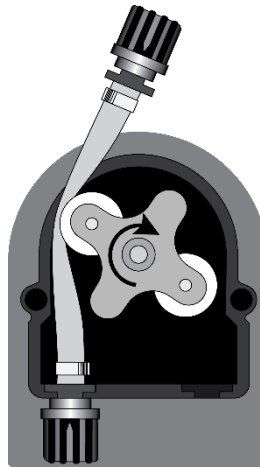

Inserire il connettore di sinistra nell'apposito alloggiamento e far passare il tubo sotto la guida del rullo. Ruotare il rullo nella direzione della freccia circolare, accompagnando contemporaneamente il tubo nella testata della pompa fino a raggiungere il connettore di destra.

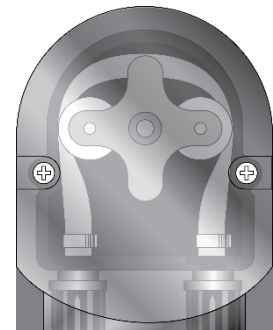



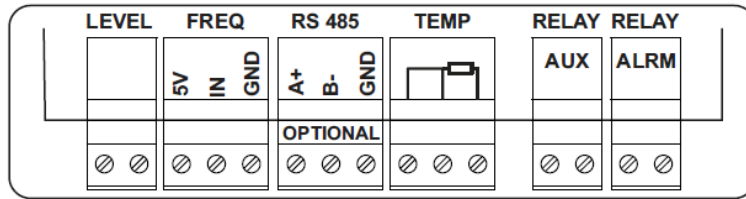

Chiudere il coperchio della pompa e premere sulla superficie in modo da bloccarlo saldamente in posizione.

PoolDose | pH · ORP

Connessioni cavi:

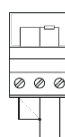

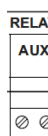
Item	Descrizione	Morsettiera
Ingresso livello:	Ingresso sonda di livello per prodotto chimico in tanica	
Ingresso Frequenza:	Ingresso di frequenza per contatore d'acqua: A: Contatore meccanico con sensore Reed B: Contatore a palette with sensore di hall	 
Porta Seriale	Non Presente , Opzionale	No Presente
Ingresso sensore temperatura:	Sensore temperature con due o tre cavi: A: Sensore Temperatura con due cavi B: Sensore Temperatura con tre cavi	 
Uscita Relè AUX	Relè contatto pulito per sistema addizionale esterno	
Uscita Relè Allarme	Relè contatto pulito per Allarme remoto.	