

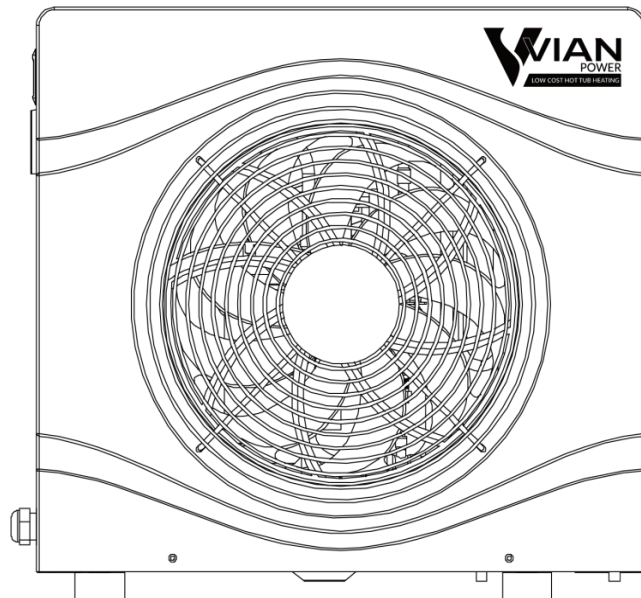

Hot Tub Heat Pump

Installation & Instruction Manual



IMPORTANT NOTE:

Thank you very much for purchasing our product. Before using your unit, please read this manual carefully and keep it for future reference.

CONTENT

1. FOREWORD	1
1.1. Read the Manual Before Operation	1
1.2. The Symbol Description of the Device	6
1.3. Statement	6
1.4. Safety Factors	6
2. OVER VIEW OF THE UNIT	9
2.1. Accessories Supplied With the Unit	9
2.2. Dimensions of the Unit	9
2.3. Main Parts of the Unit	10
2.4. Parameter of the Unit	11
3. INSTALLATION AND CONNECTION	12
3.1. Transportation	12
3.2. Installation Instruction	12
3.2.1 Pre-requirements	12
3.2.2 Location and Space	13
3.2.3 Installation Layout	13
3.2.4 Electrical Installation	14
3.2.5 Electrical Connection	15
3.3. Trial After Installation	15
3.3.1 Inspection Before Trial Running	15
3.3.2 Trial Running	15
4. REMOTE CONTROLLER OPERATION GUIDANCE	16
4.1. Control Panel Diagram	16
4.2. Key Operating Instruction	16
4.3. System Status Parameter Query	17
4.4. Trouble Shooting	18
4.5. Wi-Fi Settings	21
4.5.1 Software Installation	21

4.5.2 Software Startup	21
4.5.3 Software Registration and Configuration	22
4.5.4 Software Function Operation	30
4.5.5 Device Removal	35
5. MAINTENANCE AND WINTERZING	36
5.1 Maintenance	36
5.2 Winterizing	36

1. FOREWORD

1.1. Read the Manual Before Operation

WARNING

Do not use means to accelerate the defrosting process or to clean, other than those recommended by the manufacturer. The appliance shall be stored in a room without continuously operating ignition sources (for example: open flames, an operating gas appliance or an operating electric heater).

Do not pierce or burn.

Be aware that refrigerants may not contain an odour.

Initial safety checks shall include:

- ① That capacitors are discharged: this shall be done in a safe manner to avoid possibility of sparking;
- ② That no live electrical components and wiring are exposed while charging, recovering or purging the system;
- ③ That there is continuity of earth bonding.

Checks to the area

Prior to beginning work on systems containing flammable refrigerants, safety checks are necessary to ensure that the risk of ignition is minimized. For repair to the refrigerating system, the following precautions shall be completed prior to conducting work on the system.

Work procedure

Work shall be undertaken under a controlled procedure so as to minimize the risk of a flammable gas or vapour being present while the work is being performed.

General work area

All maintenance staff and others working in the local area shall be instructed on the nature of work being carried out. Work in confined spaces shall be avoided.

Checking for presence of refrigerant

The area shall be checked with an appropriate refrigerant detector prior to and during work, to ensure the technician is aware of potentially flammable atmospheres. Ensure that the leak detection equipment being used is suitable for use with flammable refrigerants, i.e. non-sparking, adequately sealed or intrinsically safe.

Presence of fire extinguisher

If any hot work is to be conducted on the refrigerating equipment or any associated parts, appropriate fire extinguishing equipment shall be available to hand. Have a dry powder or CO₂ fire extinguisher adjacent to the charging area.

No ignition sources

No person carrying out work in relation to a refrigeration system which involves exposing any pipe work that contains or has contained flammable refrigerant shall use any sources of ignition in such a manner that it may lead to the risk of fire or explosion. All possible ignition sources, including cigarette smoking, should be kept sufficiently far away from the site of installation, repairing, removing and disposal, during which flammable refrigerant can possibly be released to the surrounding space. Prior to work taking place, the area around the equipment is to be surveyed to make sure that there are no flammable hazards or ignition risks. "No Smoking" signs shall be displayed.

Ventilated area

Ensure that the area is in the open or that it is adequately ventilated before breaking into the system or conducting any hot work. A degree of ventilation shall continue during the period that the work is carried out. The ventilation should safely disperse any released refrigerant and preferably expel it externally into the atmosphere.

Checks to the refrigeration equipment

Where electrical components are being changed, they shall be fit for the purpose and to the correct specification. At all times the manufacturer's maintenance and service guidelines shall be followed. If in doubt consult the manufacturer's technical department for assistance.

The following checks shall be applied to installations using flammable refrigerants:

- ① The charge size is in accordance with the room size within which the refrigerant containing parts are installed;
- ② The ventilation machinery and outlets are operating adequately and are not obstructed;
- ③ If an indirect refrigerating circuit is being used, the secondary circuit shall be checked for the presence of refrigerant;
- ④ Marking to the equipment continues to be visible and legible. Markings and signs that are illegible shall be corrected;
- ⑤ Refrigeration pipe or components are installed in a position where they are unlikely to be exposed to any substance which may corrode refrigerant containing components, unless the components are constructed of materials which are inherently resistant to being corroded or are suitably protected against being so corroded.

Repairs to sealed components

DD.5.1 During repairs to sealed components, all electrical supplies shall be disconnected from the equipment being worked upon prior to any removal of sealed covers, etc. If it is absolutely necessary to have an electrical supply to equipment during servicing, then a permanently operating form of leak detection shall be located at the most critical point to warn of a potentially hazardous situation.

DD.5.2 Particular attention shall be paid to the following to ensure that by working on electrical components, the casing is not altered in such a way that the level of protection is affected. This shall include damage to cables, excessive number of connections, terminals not made to original specification, damage to seals, incorrect fitting of glands, etc.

Ensure that the apparatus is mounted securely.

Ensure that seals or sealing materials have not degraded to the point that they no longer serve the purpose of preventing the ingress of flammable atmospheres. Replacement parts shall be in accordance with the manufacturer's specifications.

Repair to intrinsically safe components

Do not apply any permanent inductive or capacitance loads to the circuit without ensuring that this will not exceed the permissible voltage and current permitted for the equipment in use. Intrinsically safe components are the only types that can be worked on while live in the presence of a flammable atmosphere. The test apparatus shall be at the correct rating.

Replace components only with parts specified by the manufacturer. Other parts may result in the ignition of refrigerant in the atmosphere from a leak.

NOTE: The use of silicon sealant can inhibit the effectiveness of some types of leak detection equipment.

Intrinsically safe components do not have to be isolated prior to working on them.

Cabling

Check that cabling will not be subject to wear, corrosion, excessive pressure, vibration, sharp edges or any other adverse environmental effects. The check shall also take into account the effects of aging or continual vibration from sources such as compressors or fans.

Detection of flammable refrigerants

Under no circumstances shall potential sources of ignition be used in the searching for or detection of refrigerant leaks. A halide torch (or any other detector using a naked flame) shall not be used.

Leak detection methods

The following leak detection methods are deemed acceptable for systems containing flammable refrigerants.

Electronic leak detectors shall be used to detect flammable refrigerants, but the sensitivity may not be adequate, or may need re-calibration. (Detection equipment shall be calibrated in a refrigerant-free area.) Ensure that the detector is not a potential source of ignition and is suitable for the refrigerant used. Leak detection equipment shall be set at a percentage of the LFL of the refrigerant and shall be calibrated to the refrigerant employed and the appropriate percentage of gas (25 % maximum) is confirmed.

Leak detection fluids are suitable for use with most refrigerants but the use of detergents containing chlorine shall be avoided as the chlorine may react with the refrigerant and corrode the copper pipe-work.

If a leak is suspected, all naked flames shall be removed/extinguished.

If a leakage of refrigerant is found which requires brazing, all of the refrigerant shall be recovered from the system, or isolated (by means of shut off valves) in a part of the system remote from the leak. Oxygen free nitrogen (OFN) shall then be purged through the system both before and during the brazing process.

Removal and evacuation

When breaking into the refrigerant circuit to make repairs – or for any other purpose – conventional procedures shall be used. However, it is important that best practice is followed since flammability is a consideration. The following procedure shall be adhered to:

- ① Remove refrigerant;
- ② Purge the circuit with inert gas;
- ③ Evacuate;
- ④ Purge again with inert gas;
- ⑤ Open the circuit by cutting or brazing.

The refrigerant charge shall be recovered into the correct recovery cylinders. The system shall be “flushed” with OFN to render the unit safe. This process may need to be repeated several times. Compressed air or oxygen shall not be used for this task.

Flushing shall be achieved by breaking the vacuum in the system with OFN and continuing to fill until the working pressure is achieved, then venting to atmosphere, and finally pulling down to a vacuum. This process shall be repeated until no refrigerant is within the system. When the final OFN charge is used, the system shall be vented down to atmospheric pressure to enable work to take place. This operation is absolutely vital if brazing operations on the pipework are to take place.

Ensure that the outlet for the vacuum pump is not close to any ignition sources and there is ventilation available.

Charging procedures

In addition to conventional charging procedures, the following requirements shall be followed:

- ① Ensure that contamination of different refrigerants does not occur when using charging equipment. Hoses or lines shall be as short as possible to minimize the amount of refrigerant contained in them. Cylinders shall be kept upright.
- ② Ensure that the refrigeration system is earthed prior to charging the system with refrigerant.
- ③ Label the system when charging is complete (if not already).
- ④ Extreme care shall be taken not to overfill the refrigeration system. Prior to recharging the system it shall be pressure tested with OFN. The system shall be leak tested on completion of charging but prior to commissioning. A follow up leak test shall be carried out prior to leaving the site.

Decommissioning

Before carrying out this procedure, it is essential that the technician is completely familiar with the equipment and all its detail. It is recommended good practice that all refrigerants are recovered safely. Prior to the task being carried out, an oil and refrigerant sample shall be taken in case analysis is required prior to re-use of reclaimed refrigerant. It is essential that electrical power is available before the task is commenced.

- ① Become familiar with the equipment and its operation.
- ② Isolate system electrically.
- ③ Before attempting the procedure ensure that:
 - Mechanical handling equipment is available, if required, for handling refrigerant cylinders;
 - All personal protective equipment is available and being used correctly;

- The recovery process is supervised at all times by a competent person;
 - Recovery equipment and cylinders conform to the appropriate standards.
- ④ Pump down refrigerant system, if possible.
 - ⑤ If a vacuum is not possible, make a manifold so that refrigerant can be removed from various parts of the system.
 - ⑥ Make sure that cylinder is situated on the scales before recovery takes place.
 - ⑦ Start the recovery machine and operate in accordance with manufacturer's instructions.
 - ⑧ Do not overfill cylinders. (No more than 80 % volume liquid charge).
 - ⑨ Do not exceed the maximum working pressure of the cylinder, even temporarily.
 - ⑩ When the cylinders have been filled correctly and the process completed, make sure that the cylinders and the equipment are removed from site promptly and all isolation valves on the equipment are closed off.
 - ⑪ Recovered refrigerant shall not be charged into another refrigeration system unless it has been cleaned and checked.

Labeling

Equipment shall be labeled stating that it has been decommissioned and emptied of refrigerant. The label shall be dated and signed. Ensure that there are labels on the equipment stating the equipment contains flammable refrigerant.

Recovery

When removing refrigerant from a system, either for servicing or decommissioning, it is recommended good practice that all refrigerants are removed safely. When transferring refrigerant into cylinders, ensure that only appropriate refrigerant recovery cylinders are employed. Ensure that the correct number of cylinders for holding the total system charge are available. All cylinders to be used are designated for the recovered refrigerant and labeled for that refrigerant (i.e. special cylinders for the recovery of refrigerant). Cylinders shall be complete with pressure relief valve and associated shut-off valves in good working order. Empty recovery cylinders are evacuated and, if possible, cooled before recovery occurs.

The recovery equipment shall be in good working order with a set of instructions concerning the equipment that is at hand and shall be suitable for the recovery of flammable refrigerants.

In addition, a set of calibrated weighing scales shall be available and in good working order.





Hoses shall be complete with leak-free disconnect couplings and in good condition. Before using the recovery machine, check that it is in satisfactory working order, has been properly maintained and that any associated electrical components are sealed to prevent ignition in the event of a refrigerant release. Consult manufacturer if in doubt.

The recovered refrigerant shall be returned to the refrigerant supplier in the correct recovery cylinder, and the relevant Waste Transfer Note arranged. Do not mix refrigerants in recovery units and especially not in cylinders.

If compressors or compressor oils are to be removed, ensure that they have been evacuated to an acceptable level to make certain that flammable refrigerant does not remain within the lubricant. The evacuation process shall be carried out prior to returning the compressor to the suppliers. Only electric heating to the compressor body shall be employed to accelerate this process. When oil is drained from a system, it shall be carried out safely.

1.2. The Symbol Description of the Device

The precautions listed here are divided into the following types. They are quite important, so be sure to follow them carefully. Meanings of DANGER, WARNING, CAUTION and NOTE symbols.

Symbols	Meaning	Description
	WARNING	The symbol shows that this appliance uses a flammable refrigerant. If the refrigerant is leaked and exposed to an external ignition source, there is a risk of fire.
	WARNING	The symbol shows that this appliance uses a low burning velocity material. Please keep away from fire source.
	CAUTION	This symbol shows that the operation manual should be read carefully.
	CAUTION	This symbol shows that a service personnel should be handling this equipment with reference to the installation manual.
	CAUTION	This symbol shows that information is available such as the operating manual or installation manual.

1.3. Statement

To keep users under safe working condition and property safety, please follow the instructions below:

- ① Wrong operation may result in injury or damage;
- ② Please install the unit in compliance with local laws, regulations and standards;
- ③ Confirm power voltage and frequency;
- ④ The unit is only used with grounding sockets;
- ⑤ Independent switch must be offered with the unit.

1.4. Safety Factors

The following safety factors need to be considered:

- ① Please read the following warnings before installation;
- ② Be sure to check the details that need attention, including safety factors;
- ③ After reading the installation instructions, be sure to save them for future reference.

Warning

Make sure that the unit is installed safely and reliably.

- If the unit is not secure or not installed, it may cause damage. The minimum support weight required for installation is 21g/mm²

- If the unit was installed in a closed area or limited space, please consider the size of room and ventilation to prevent suffocation caused by refrigerant leakage.

- ① Use a specific wire and fasten it to terminal block so that the connection will prevent pressure from being applied to parts.

- ② Wrong wiring will cause fire.

Please connect power wire accurately according to wiring diagram on the manual to avoid burnout of the unit or fire.

- ③ Be sure to use correct material during installing.

Wrong parts or wrong materials may result in fire, electric shock, or falling of the unit.

- ④ Install on the ground safely, please read installation instructions.

Improper installation may result in fire, electric shock, falling of the unit, or water leaking.

- ⑤ Use professional tools for doing electrical work.

If power supply capacity is insufficient or circuit is not completed, it may cause fire or electric shock.

- ⑥ The unit must have grounding device.

If power supply does not have grounding device, be sure not to connect the unit.

- ⑦ The unit should be only removed and repaired by professional technician.

Improper movement or maintenance of the unit may cause water leakage, electric shock, or fire.

Please find a professional technician to do.

- ⑧ Don't unplug or plug power during operation. It may cause fire or electric shock.

- ⑨ Don't touch or operate the unit when your hands are wet. It may cause fire or electric shock.

- ⑩ Don't place heaters or other electrical appliances near the power wire. It may cause fire or electric shock.

- ⑪ The water must not be poured directly from the unit. Do not let water to permeate into the electrical components.

 **Warning**

- ① Do not install the unit in a location where there may be flammable gas.

- ② If there is flammable gas around the unit, it will cause explosion.

According to the instruction to carry out drainage system and pipeline work. If drainage system or pipeline is defective, water leakage will occur. And it should be disposed immediately to prevent other household products from getting wet and damage.

- ③ Do not clean the unit while power is on. Turn off power before cleaning the unit. If not it may result in injury from a high-speed fan or electric shock.

- ④ Stop operating the unit once there is a problem or an fault code.

Please turn off power and stop running the unit. Otherwise it may cause electric shock or fire.

- ⑤ Be careful when the unit is not packed or not installed.

Pay attention to sharp edges and fins of heat exchanger.

- ⑥ After installation or repair, please confirm refrigerant is not leaking.

If refrigerant is not enough, the unit will not work properly.

- ⑦ The installation of external unit must be flat and firm.

Avoid abnormal vibration and noise.

- ⑧ Don't put your fingers into fan and evaporator.

High speed running fan will result in serious injury.

⑨ This device is not designed for people who is physically or mentally weak (including children) and who does not have experience and knowledge of heating and cooling system. Unless it is used under direction and supervision of professional technician, or has received training on the using of this unit. Children must use it under supervision of an adult to ensure that they use the unit safely. If power wire is damaged, it must be replaced by a professional technician to avoid danger.

2. OVER VIEW OF THE UNIT

2.1. Accessories Supplied With the Unit

After unpacking, please check if you have all the following components.

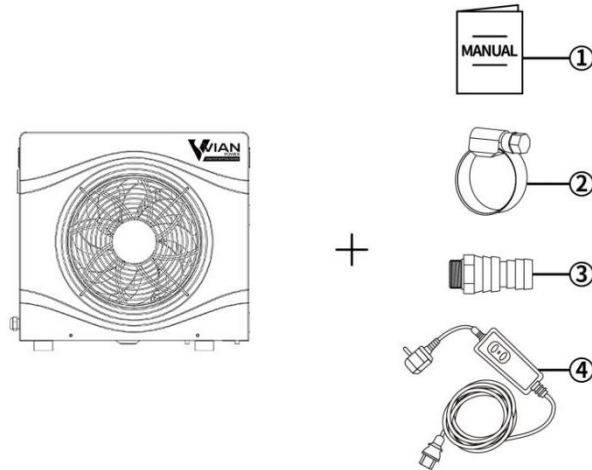

NO.	Components	Quantity	NO.	Components	Quantity
①	User Manual	1	③	Adapter	2
②	Hose Clamp	2	④	RCD leakage protection power cord	1

2.2. Dimensions of the Unit

Dimension Unit: (mm)

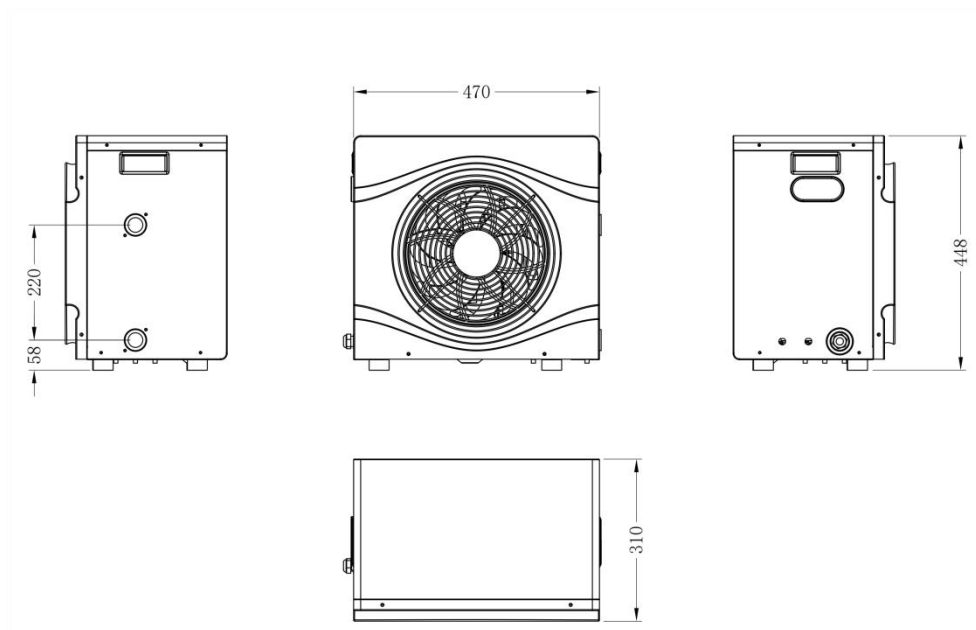

2.3. Main Parts of the Unit

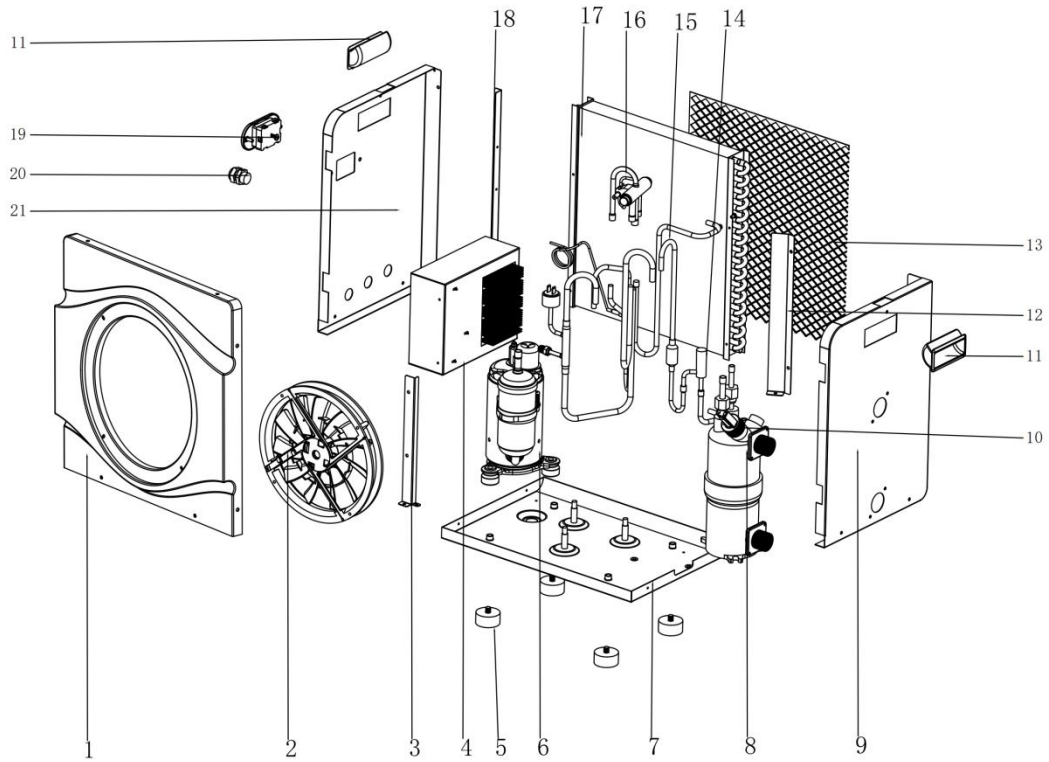

1	Front plate	8	Titanium tube heat exchanger	15	Pipe assembly
2	Fan motor	9	Right plate	16	Four-way valve
3	PCB box support	10	Water flow switch	17	High efficiency finned heat exchanger
4	PCB box	11	Handle	18	Back support-left part
5	Rubber feet	12	Back support-right part	19	Wire controller
6	Compressor	13	Back net	20	Power supply waterproof connector
7	Bottom plate	14	EEV	21	Left plate

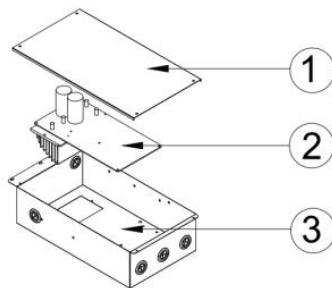

①	Electrical Box Cover	②	Main Board	③	Electrical Box
---	----------------------	---	------------	---	----------------

2.4. Parameter of the Unit

Model	HP-VP501
Heating Capacity: Ambient 26°C, Inlet/Outlet: 26/28°C, Humidity 80%	
Heating Capacity (kW)	2.1~5.1
Power Input (kW)	0.168~0.898
COP	12.5~5.68
Heating Capacity: Ambient 15°C, Inlet/Outlet: 26/28°C, Humidity 70%	
Heating Capacity (kW)	1.36~3.8
Power Input (kW)	0.194~0.844
COP	7.0~4.5
Cooling Capacity: Ambient 35°C, Inlet/Outlet: 27/-°C	
Cooling Capacity (kW)	1.31~3.0
Power Input (kW)	0.262~1.00
EER	5.0~3.0
General Information	
Max Power Input (kW)	1.5
Max Current (A)	6.9
Advised Pool Size (m ³)	8~20
Controller	LED Controller
Wi-Fi Function	Yes
Power Supply	220-240V~/50Hz
Water Temp. Heating Mode (°C)	15~40°C
Running Ambient Temp. (°C)	-10~43°C
Refrigerant	R32
Compressor Brand/Type	GMCC / Rotary
Manometer	Yes
Gas Control	EEV
Heat Exchanger	Titanium Heat Exchanger
Water Pipe Connection (mm)	φ32 or φ38
Water Flow (m ³ /h)	2.5
Noise dB(A)	45
Net Weight (kg)	23.5
Net Dimensions(L/W/H)mm	470*290*430
Water Pressure Drop (kPa)	12
Water Proof Class	IPX4

3. INSTALLATION AND CONNECTION

⚠ WARNING: The heat pump must be installed by a professional team. The users are not qualified to install by themselves, otherwise the heat pump might be damaged and risky for users' safety.

This section is provided for information purposes only and must be checked and adapted if necessary according to the actual installation conditions.

3.1. Transportation

1. When storing or moving the heat pump, the heat pump should be at the upright position.

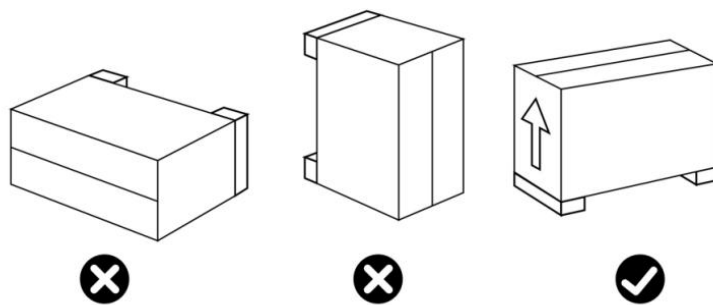

2. When moving the heat pump, do not lift the water union since the titanium heat exchanger inside the heat pump will be damaged.

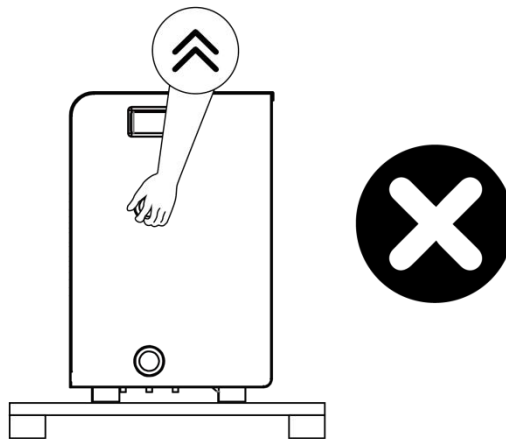

3.2. Installation Instruction

3.2.1 Pre-requirements

Equipment necessary for the installation of your heat pump:

- ① Power supply cable suitable for the unit's power requirements.
- ② A By-Pass kit and an assembly of PVC tubing suitable for your installation as well as stripper, PVC adhesive and sandpaper.

- ③ A set of wall plugs and expansion screws suitable to attach the unit to your support.
- ④ We recommend that you connect the unit to your installation by means of flexible PVC pipes in order to reduce the transmission of vibrations.
- ⑤ Suitable fastening studs may be used to raise the unit.

3.2.2 Location and Space

Please comply with the following rules concerning the choice of heat pump location.

- ① The unit's future location must be easily accessible for convenient operation and maintenance.
- ② It must be installed on the ground, fixed ideally on a level concrete floor. Ensure that the floor is sufficiently stable and can support the weight of the unit.
- ③ A water drainage device must be provided close to the unit in order to protect the area where it is installed.
- ④ If necessary, the unit may be raised by using suitable mounting pads designed to support its weight.
- ⑤ Check that the unit is properly ventilated, that the air outlet is not facing the windows of neighbouring buildings and that the exhaust air cannot return. In addition, provide sufficient space around the unit for servicing and maintenance operations.
- ⑥ The unit must not be installed in an area exposed to oil, flammable gases, corrosive products, sulphur compounds or close to high frequency equipment.
- ⑦ To prevent mud splashes, do not install the unit near a road or track.
- ⑧ To avoid causing nuisance to neighbors, make sure the unit is installed so that it is positioned towards the area that is least sensitive to noise.
- ⑨ Keep the unit as much as possible out of the reach of children.
- ⑩ Installation space:

Unit: mm

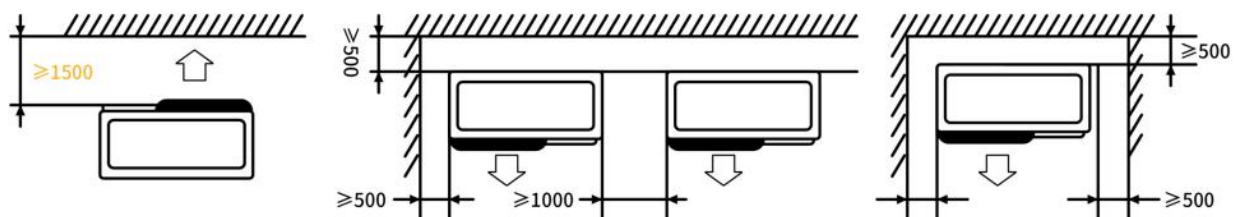

Do not put anything when the distance from the heat pump is less than 1 meter.

Leave 500 mm of empty space on the sides and back of the heat pump and free ventilation above

Do not leave any obstacles above or in front of the device!

3.2.3 Installation Layout

Notice: The filter must be cleaned regularly to ensure that water in the system is clean and avoid blocking of filter. It is necessary that drainage valve is fixed on the lower water pipe. If the unit is not running during winter months, please disconnect power supply and let out drain water from

unit through drainage valve. If ambient temperature of running unit is below 0°C, please keep water pump running.

The installation diagram is shown in the following figure:

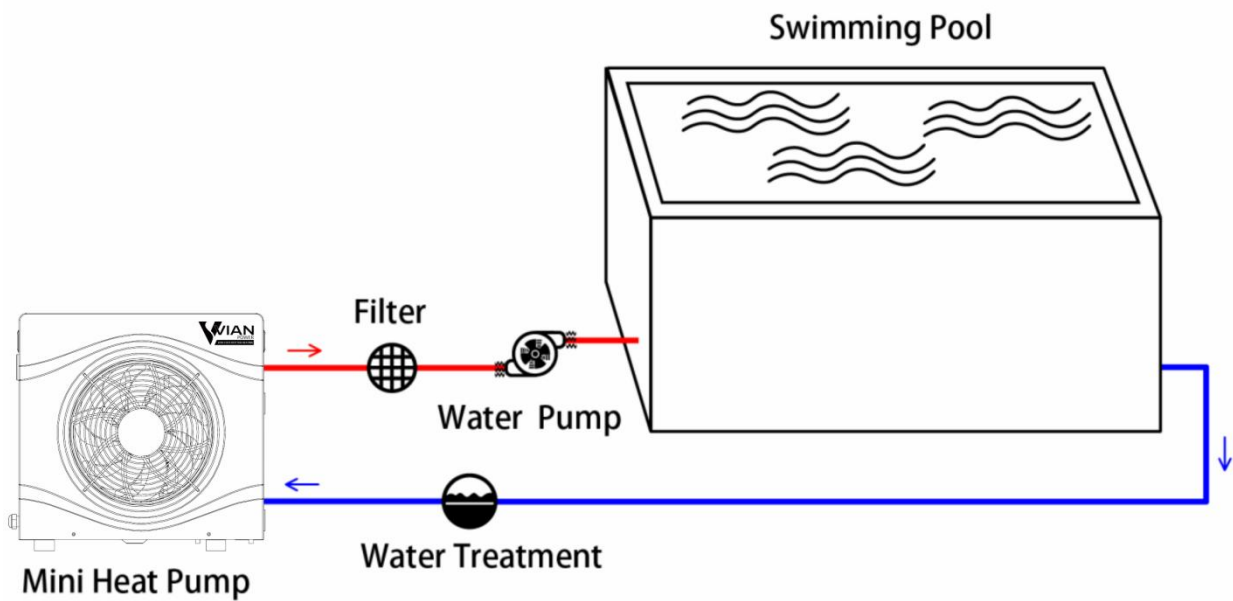

No.	Item	Quantity
1	Mini Heat Pump	1
2	Filter	1
3	Water Pump	1
4	Water Treatment	1
5	Swimming Pool	1

3.2.4 Electrical Installation

To function safely and maintain the integrity of your electrical system, the unit must be connected to a general electricity supply in accordance with the following regulations:

- ① Upstream, the general electricity supply must be protected by a 30mA differential switch.
- ② The heat pump must be connected to a suitable D-curve circuit breaker in accordance with current standards and regulations in the country where the system is installed.
- ③ The electricity supply cable must be adapted to match the unit's rated power and the length of wiring required by the installation. The cable must be suitable for outdoor use.
- ④ For a three-phase system, it is essential to connect the phases in the correct sequence. If the phases are inverted, the heat pump's compressor will not work.
- ⑤ In places open to the public, it is mandatory to install an emergency stop button close to the heat pump.

Model	Power Supply Wires
-------	--------------------

	Electricity Supply	Cable Diameter	Specification
HP-VP501	220-240V~/ 50Hz	3G 1.5mm ²	AWG 16

3.2.5 Electrical Connection

⚠ WARNING: Power supply of heat pump must be disconnected before any operation.

Please comply with the following instruction to connect heat pump.

Step 1: Prepare a socket

Step 2: Insert plug into socket as the following picture shows

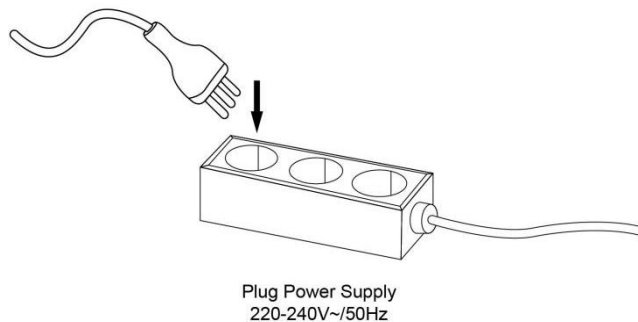

3.3. Trial After Installation

⚠ WARNING: Please check all the wiring carefully before turning on the heat pump.

3.3.1 Inspection Before Trial Running

Before running test, confirm below items and write √ in block;

<input type="checkbox"/>	Correct unit installation
<input type="checkbox"/>	Power supply voltage is the same as unit rated voltage
<input type="checkbox"/>	Correct piping and wiring
<input type="checkbox"/>	Air inlet & outlet port of unit is unblocked
<input type="checkbox"/>	Drainage and venting is unblocked and no water leaking
<input type="checkbox"/>	Leakage protector is working
<input type="checkbox"/>	Piping insulation is working
<input type="checkbox"/>	Ground wire is connected correctly

3.3.2 Trial Running

Step 1: Running test can begin after completing all installation;

Step 2: All wiring and piping should be connected well and carefully checked, then fill water tank with water before power is switched on;

Step 3: Emptying all air within pipes and water tank, press “on-off” button on control panel to run the unit at setting temperature;

Step 4: Items need to be checked during running test:

① During the first running, unit current is normal or not;







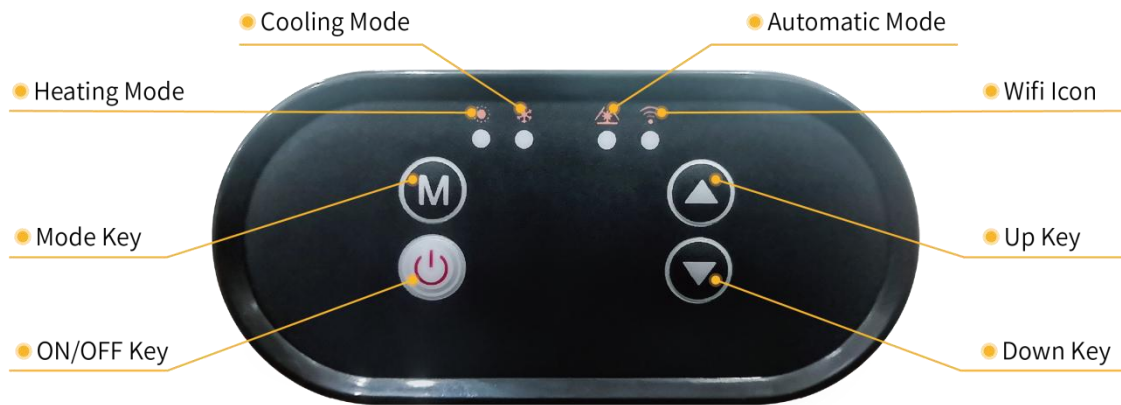

- ② Each function button on control panel is normal or not;
- ③ Display screen is normal or not;
- ④ Are there any leakage in the whole heating circulation system;
- ⑤ Condensate drain is normal or not;
- ⑥ Are there any abnormal sound or vibration during running?









4. REMOTE CONTROLLER OPERATION GUIDANCE

4.1. Control Panel Diagram



4.2. Key Operating Instruction

NO.	Item	Operation Way
1	ON/OFF	When the controller is turned off, only the water temp. is displayed and the mode cannot be switched; When press  to turn on the controller, the mode light before the controller turns on.
2	Mode Switching Function	In the startup state, briefly press  to switch the heat/silent/cooling mode; In the shutdown state, you cannot switch mode.
3	Temp. Setting Function	Under the startup state, briefly press  or  to directly enter the temp. setting function of the current mode. At this time, the setting temp. indicator is flashing. And the user can adjust the setting temp. through  and  . After the setting is completed, you have two way to save the setting value and exit this function: ①Waiting for the setting temp. indicator to stop flashing. ② Pressing the  or  to exit.

NO.	Item	Operation Way
4	Status Query Function	Under the water temp. display interface, long press  3s to enter the state query interface. Through  and  can select the query parameters. And press  again to view the value of the corresponding parameters.
5	Recovery Default Parameter Function	When shutdown, press  10s and all mode lights flash once. Then release the button and wait for "- -" at the interface. Recovery occurs when "- -" appears. This function is only valid within 5min before the wire control on power.
6	Manual Defrost Function	Under the water temp. display interface, press  and  5s. After all the mode lights flash once, release the button and enter the manual defrost function. The main control board determines whether to enter the manual frost function according to the conditions. And the cooling mode indicator continues to flash during the defrost process.
7	Lock/Unlock Function	The wire controller automatically locks the button and reduces the brightness of the screen when there is no operation within 60s. The user needs to press  and  at the same time to unlock. And all mode lights will flash once.

4.3. System Status Parameter Query

Code	Parameter Name	Display Range	Unit	Note
C1	Compressor 1 frequency	0 ~ 120	Hz	
C3	Inlet water temp.	-99 ~ 999	°C	
C4	Coil temp.(Heating)	-99 ~ 999	°C	
C5	Exhaust temp.	-99 ~ 999	°C	
C6	Suction temp.	-99 ~ 999	°C	
C7	Coil temp.(Cooling)	-99 ~ 999	°C	
C8	Ambient temp.	-99 ~ 999	°C	
C11	Out water temp.	-99 ~ 999	°C	
C16	Water tank temp.	-99 ~ 999	°C	

Code	Parameter Name	Display Range	Unit	Note
C17	Main valve 1 opening step	0 ~ 999	P	
C21	High pressure value	0 ~ 10.0	MPa	
C22	Low pressure value	0 ~ 10.0	MPa	
C23	High pressure saturation temp.	-99 ~ 999	°C	
C24	Low pressure saturation temp.	-99 ~ 999	°C	
C25	Drive 1-AC voltage	0 ~ 999	V	
C26	Drive 1-AC current	0 ~ 99.9	A	
C27	Drive 1-DC bus voltage	0 ~ 999	V	
C28	Drive 1-compressor phase current	0 ~ 99.9	A	
C29	Drive 1-IPM module temp.	-99 ~ 999	°C	
C30	Drive 1-DC fan 1 speed	0 ~ 999	rpm	
C31	Drive 1-DC fan 2 speed	0 ~ 999	rpm	

4.4. Trouble Shooting

System protection/error indication

In the running process of unit, the unit may be faulted if the following code is displayed, please turn off power switch of the unit and turn on power switch of unit again after 30 seconds. The code is no longer displayed, that means the unit could be used again. If the code is displayed again, please contact our company for trouble shooting.

Code	Fault Name	Action
E03	AC current protection	Shutdown protection
E04	AC voltage protection	Shutdown protection
E05	DC voltage protection	Shutdown protection
E06	Phase current protection	Shutdown protection
E07	High IPM temp. protection	Shutdown protection
E09	High exhaust temp. protection	Shutdown protection
E14	Low outlet water temp. protection	Shutdown protection
E15	High coil temp. protection (cooling)	Shutdown protection
E16	High outlet water temp. protection (heating)	Shutdown protection
E17	Flow switch fault	Shutdown protection
E18	High pressure switch fault	Shutdown protection
E19	Low pressure switch fault (pass, shut down after 30s)	Shutdown protection

E22	Inlet and outlet temp. difference too high protection	Shutdown protection
E23	Low ambient temp. protection(heating)	Shutdown protection
E24	Low ambient temp. protection(cooling)	Shutdown protection
E25	Low inside coil temp. protection(cooling)	Shutdown protection
E26	DC Fan fault(No feedback speed)	Shutdown protection
E49	Inlet sensor fault	Use outlet water replace logical judgment
E50	Coil sensor fault	Cancel the corresponding logical judgment
E51	Discharge sensor fault	Shutdown protection
E52	Suction sensor fault	Cancel the corresponding logical judgment
E53	Inside coil sensor fault(cooling)	Use outlet water replace logical judgment
E54	Ambient sensor fault	Cancel the corresponding logical judgment
E57	Outlet sensor fault	Cancel the corresponding logical judgment
D17	Driver IPM over current protection	System 1 shutdown
D18	Driver 1 compressor drive fault(except IPM)	System 1 shutdown
D19	Driver 1 compressor over current protection	System 1 shutdown
D22	Driver IPM over temp. protection	System 1 shutdown
D23	Driver PFC fault	System 1 shutdown
D24	Driver 1 DC bus over voltage protection	System 1 shutdown
D25	Driver 1 DC bus under voltage protection	System 1 shutdown
D26	Driver 1AC under voltage protection	System 1 shutdown
D27	Driver 1 AC over current protection	System 1 shutdown
D33	Driver 1 IPM temp. protection	System 1 shutdown
D34	Drive 1 DC fan 1 fault	System 1 shutdown
D36	Driver 1 transformer output 15V under voltage protection	System 1 shutdown

Other Malfunctions and Solutions(No display on LED wire control)

Phenomenon	Cause	Solution
Unit is not running	<ol style="list-style-type: none"> 1. Power outage 2. Power switch is not connected 3. Power switch fuse is burned-out 4. Timing is not up 	<ol style="list-style-type: none"> 1. Please wait for power supply recovery 2. Connect power 3. Replace fuse 4. Please wait or cancel timing setting

Phenomenon	Cause	Solution
Unit is not running after starting up	<ol style="list-style-type: none"> 1. Compressor protection time interval is not up 2. Water temperature of the unit does not reach starting up water temperature value 	<ol style="list-style-type: none"> 1. Please wait patiently for the end of protection time 2. Normal phenomenon and wait for water temperature to reach
Unit is running normally, but hot water temperature is low	<ol style="list-style-type: none"> 1. Improper temperature setting 2. Large hot water consumption 3. Air inlet port or outlet port of outdoor machine or indoor machine is blocked 	<ol style="list-style-type: none"> 1. Set up proper temperature 2. Wait for temperature of hot water to rise 3. Clear tuyere obstruction
Unit is running automatically	Reach timing to start up	Please shutdown manually or cancel timing if needn't start up

4.5. Wi-Fi Settings

4.5.1 Software Installation

- ① Method 1: Search "Smart life" in your APP store ,install "".Click "GET" to install.

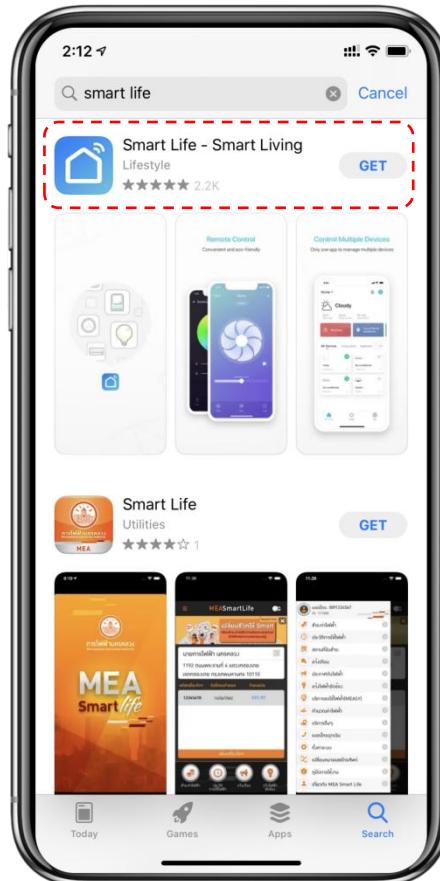

- ② Method 2: Scan the QR code below.



For IOS/Android Users

4.5.2 Software Startup

After installation,click "" on your desktop to start up Smart Life.



4.5.3 Software Registration and Configuration

1. Registration

① Users don't have account can click "Register" to create an account: Register → Enter your phone number → Get Verification Code → Enter Verification Code → Set Code;

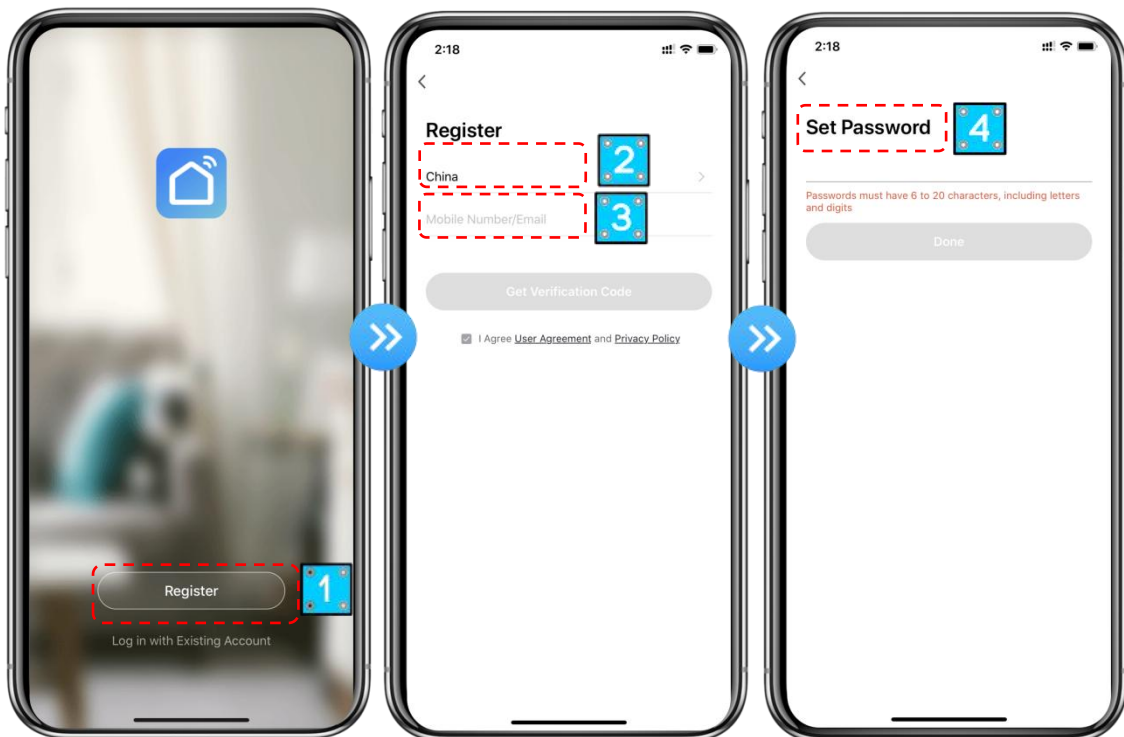

② After registration, you need to Create a Home: Create a Home → Set Home Name → Set Home Location → Add Rooms.

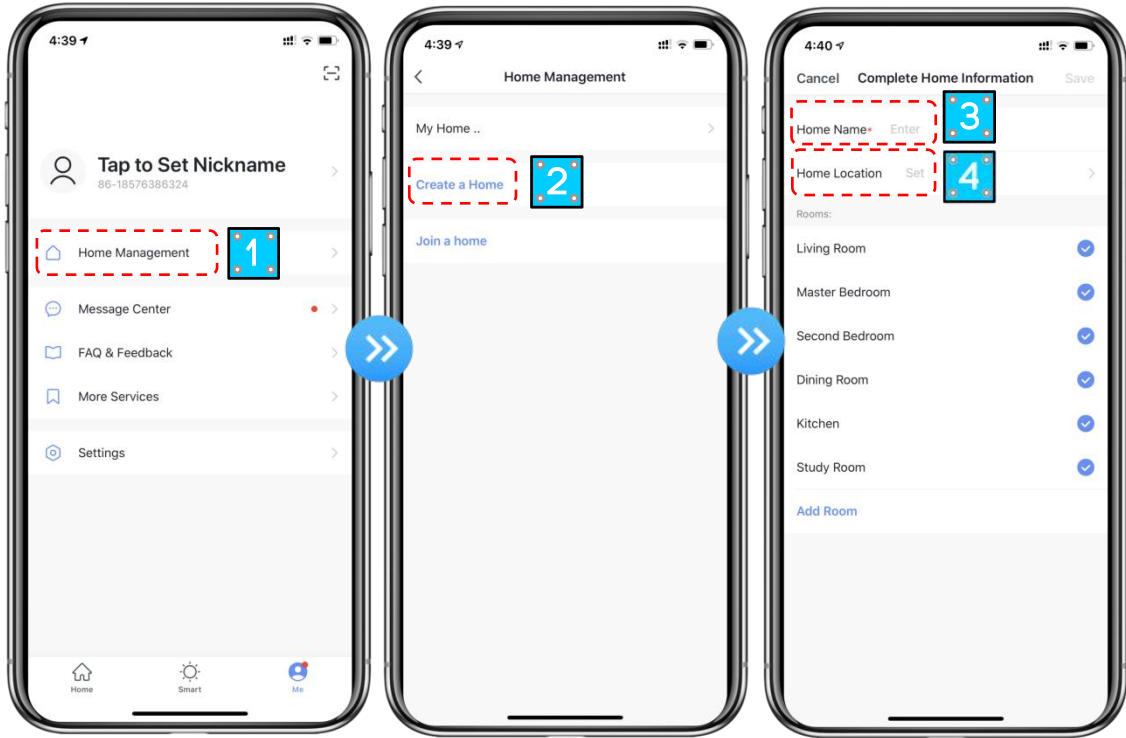

2. Account ID+ Password Login

① Existing accounts can be logged in directly, in the following order.

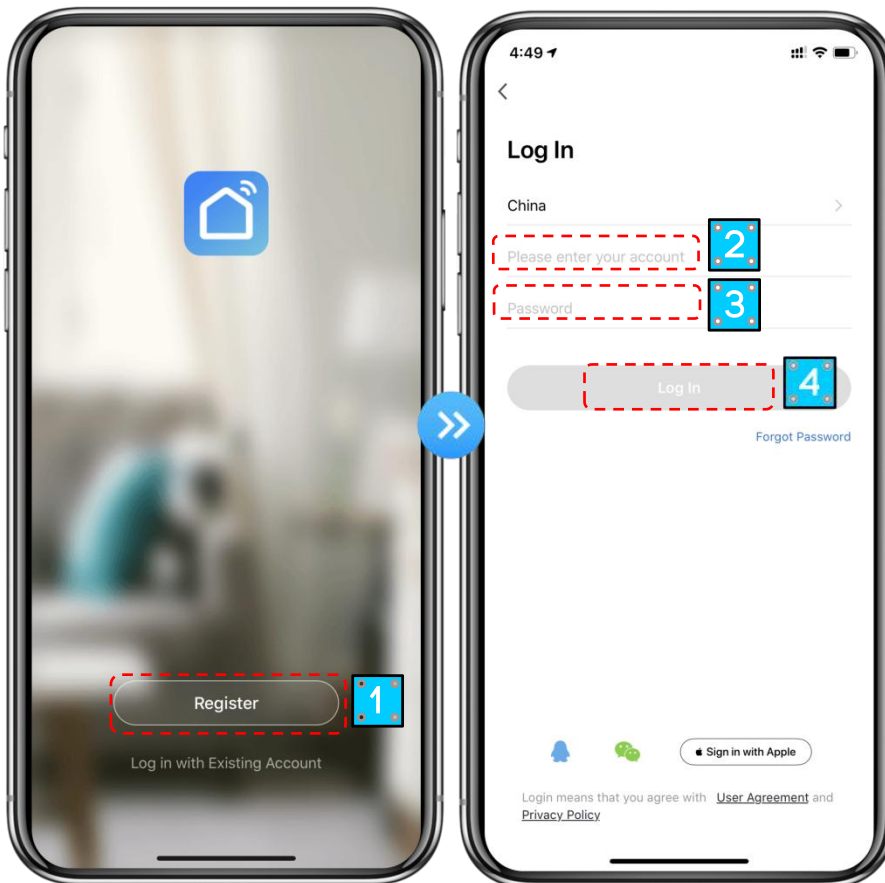

② If you forget your password you can choose to login with your verification code and select "Forget Password": Enter your phone number → Get verification code .

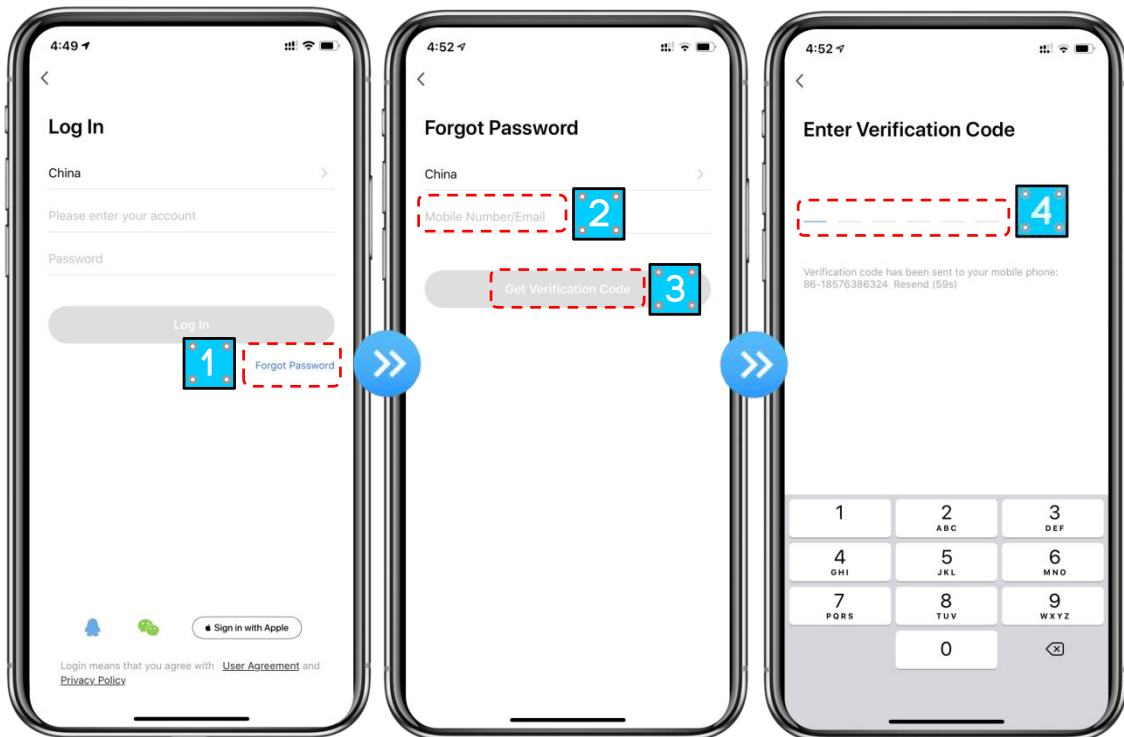

③ After creating a home or logged in, enter the main interface of APP.



Note:

Click the device to check the status, and you can set the operating mode, ON/OFF, timer. Click “+” to add devices.

3. Wi-Fi Module configuration steps:

Method 1

Step 1:

EZ Mode: When power is on, press and hold the "▲" and "⏻" keys at the same time for 5 seconds to enter the distribution network. The "📶" icon will flash rapidly;.

Step 2:

Turn on the phone's Wi-Fi function and connect to the Wi-Fi hot-spot. The Wi-Fi hot-spot must be able to connect to the Internet normally;

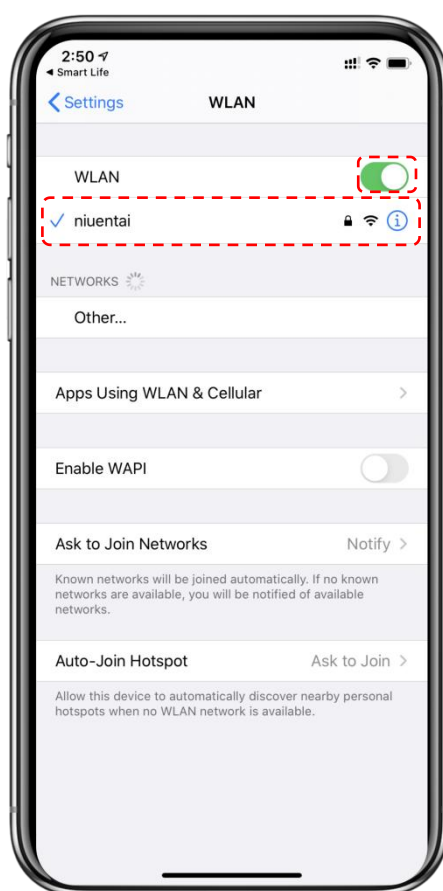

Step 3:

Open the "smart life" APP, log in into the main interface, click on the top right corner "+" or "add equipment" of the interface, enter the equipment type selection, the "Large Home Appliances" , select "Smart Heat Pump" equipment and add equipment into the interface.

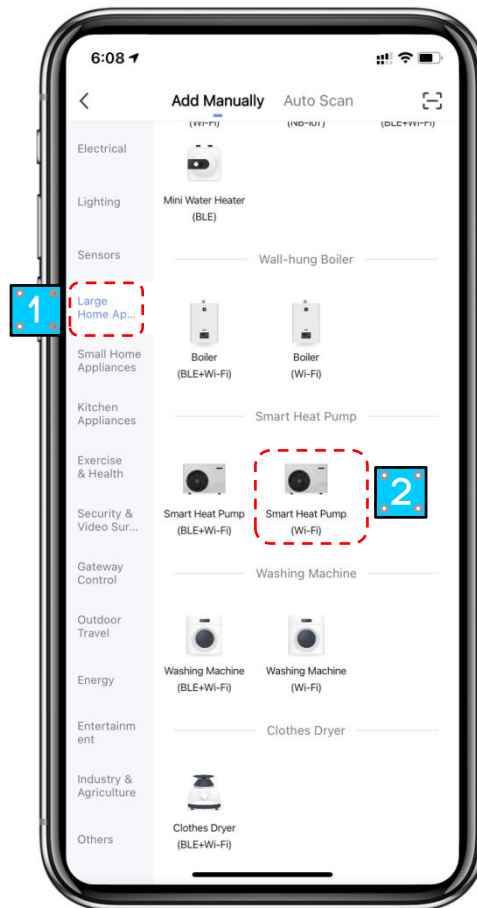

Step 4:

After selecting "Smart Heat Pump", enter the interface of "Add Equipment", and confirm that the wire controller has selected the EZ mode. After the indicator light under "📶" flashes rapidly , click "Confirm indicator rapidly blink ".

Enter the Wi-Fi connection interface, enter the Wi-Fi password of the mobile phone (it must be the same as the Wi-Fi of the mobile phone), click "Next", and then directly enter the connected status of the device.

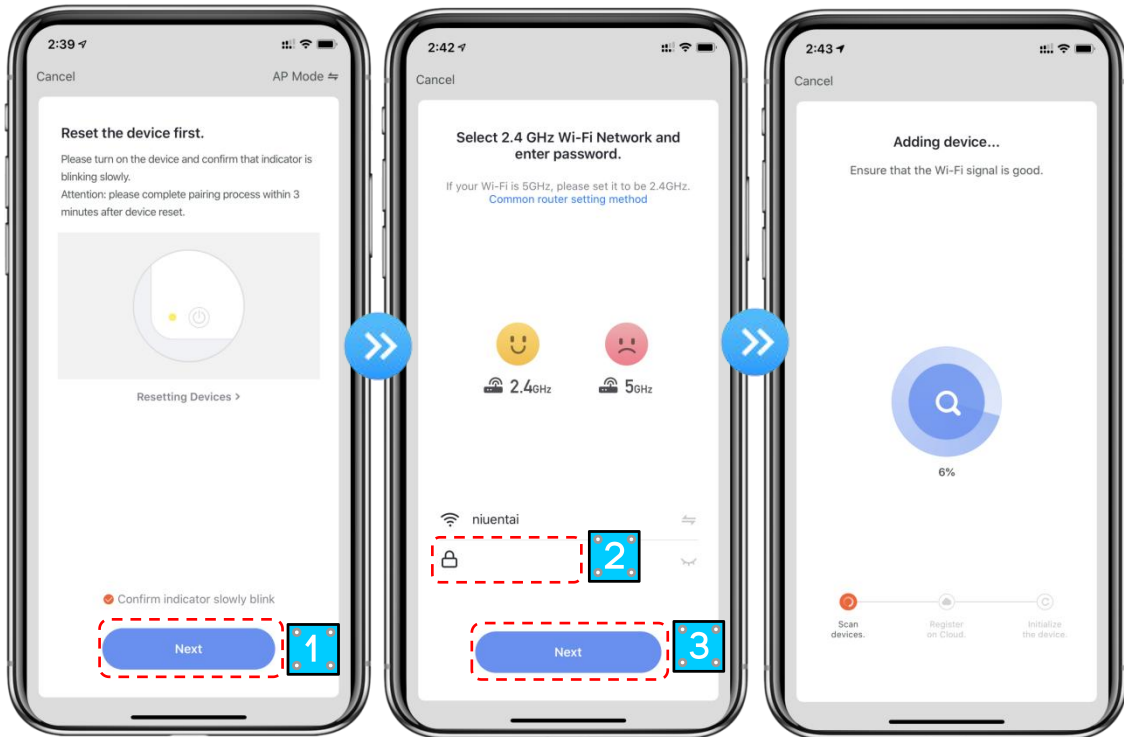

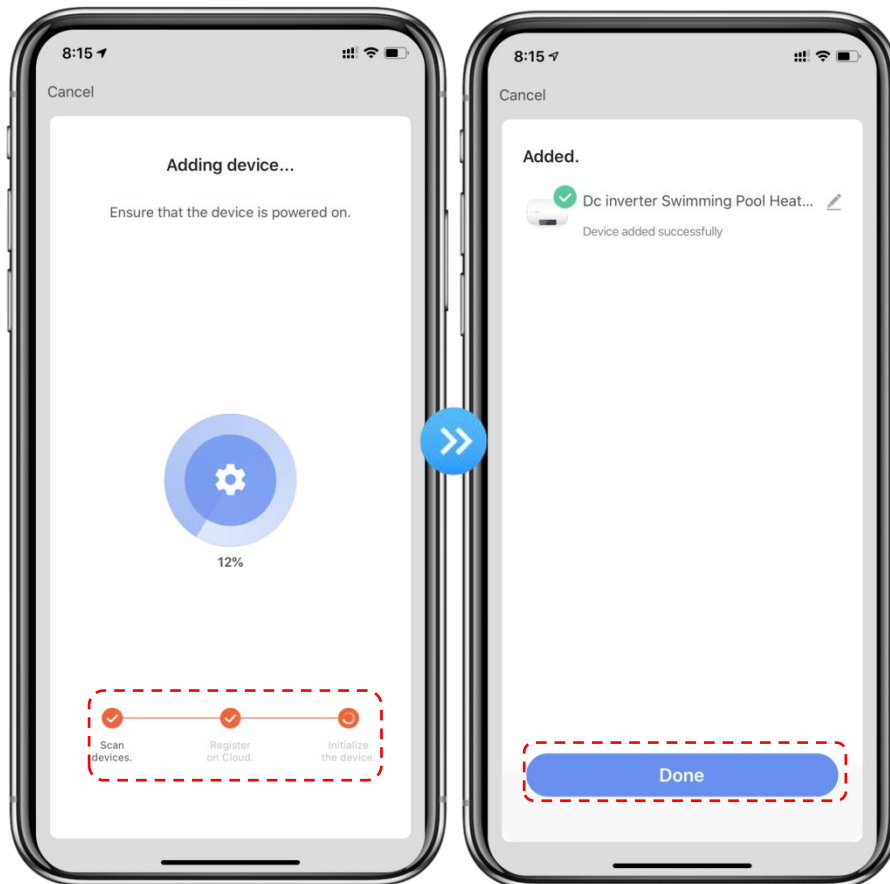

Step 5:

When “Scan devices”, “Register on Cloud”, “Initialize the device” are all completed, connect succeeds.



Method 2

Step 1

AP Mode: Press and hold the "  " and "  " keys at the same time for 5 seconds to enter the distribution network. The "  " icon will flash slowly.

Step 2&3

Same with EZ Mode above.

Step 4

After entering the add device interface, click "EZ Mode" in the upper right corner; Enter the AP mode to add the device interface, confirm that the AP mode has been selected, and click "Confirm indicator slowly blink".

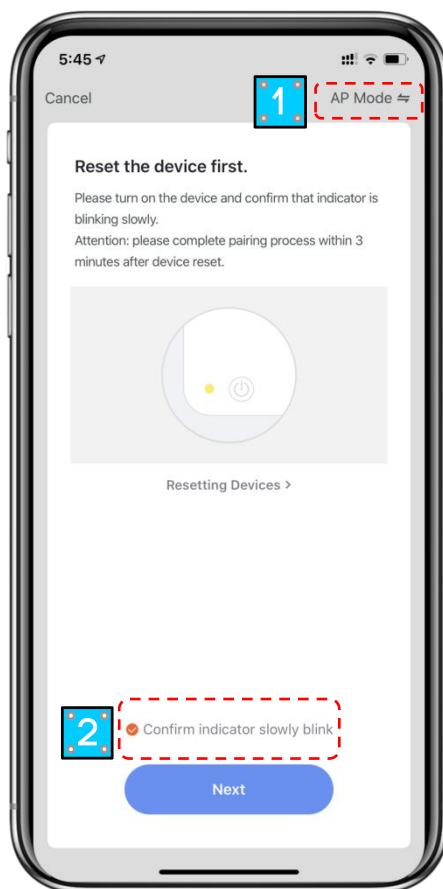

The interface of Wi-Fi connection will pop up, enter the Wi-Fi password of the mobile phone (it must be the same as the Wi-Fi of the mobile phone), click "Next", "Connect your mobile phone to the device's hot spot" will pop up, and click "Go to Connect";

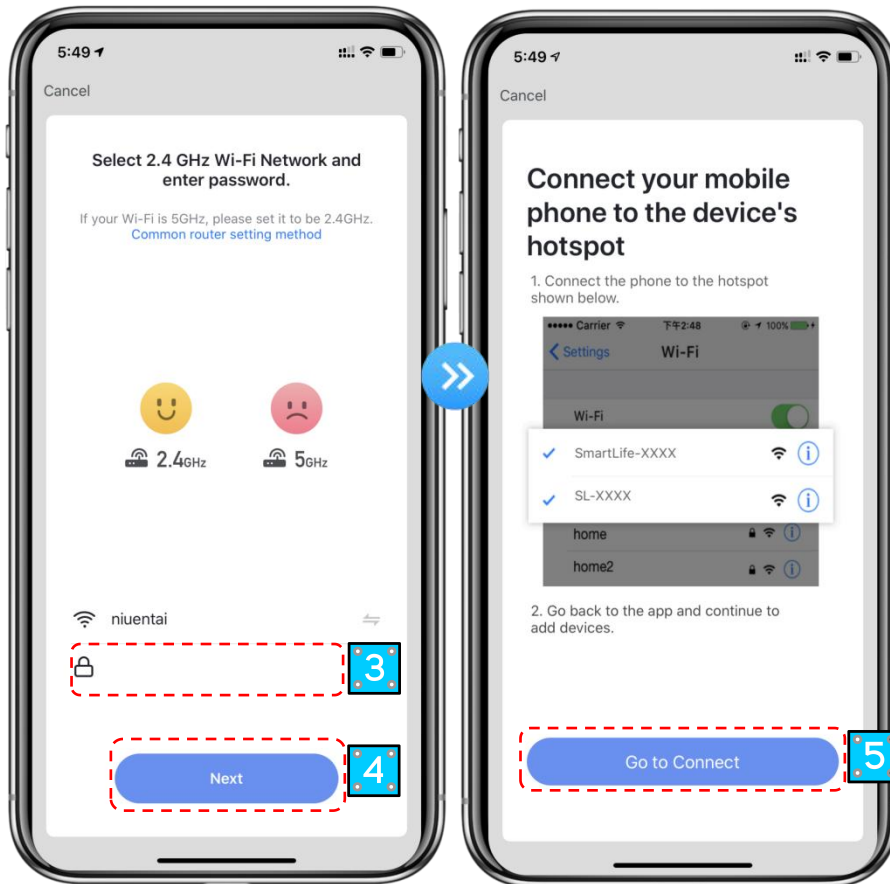

Enter the mobile phone Wi-Fi connection interface, find the “Smart Life_XXXX” connection, and the APP will automatically enter the device connection status.

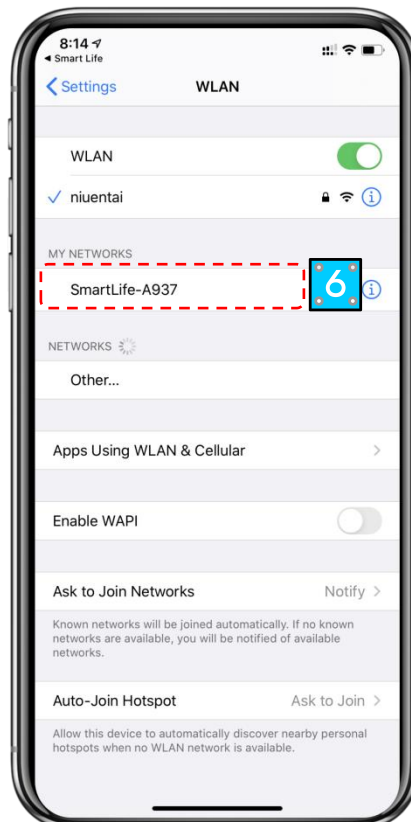

Step 5 : Same as EZ mode above.

Note: If the connection is failed, please enter the AP mode manually and reconnect according to the above steps.

4.5.4 Software Function Operation

- After the device is bound successfully, enter the operation interface of “Smart heat pump” (Device name, modifiable)
- In the main interface of “Smart Life”, click “Smart heat pump” to enter the operation interface.



① Back

② More: You can change device name, select device installation location, check networking status, add Shared users, create device cluster, view device information, and more.

③ Setting temperature adjustment: The circle slides counterclockwise to reduce the temperature, but clockwise to increase the temperature.

④ Target temperature

⑤ Current temperature

⑥ Mode switching: Click to select the mode to be switched.

⑦ ON/OFF

⑧ Timing: Click to add timing off/on time.

● **Modify device name**

Click in the following order to enter device details, and click "Device Name" to rename the device.

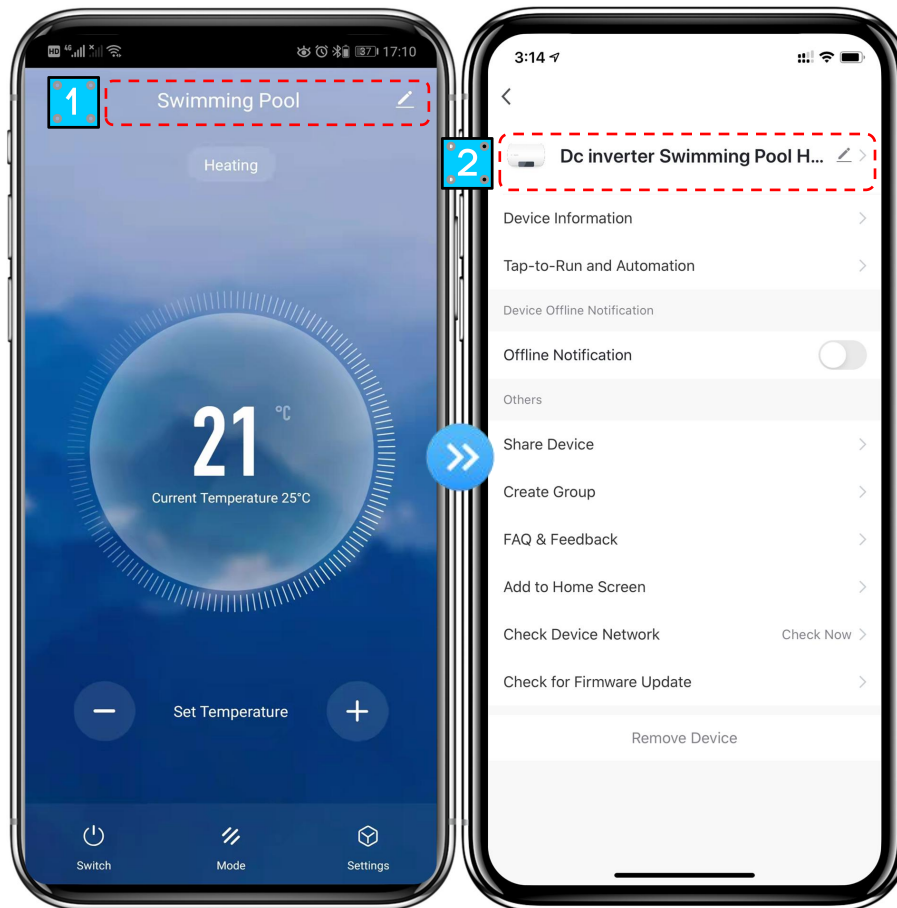

● Device sharing

- ◆ To share a bound device, the user should do so in the following order.
- ◆ After successful sharing, the list will be added to show the person shared
- ◆ If you want to delete the account you shared to, cross the selected account to the left, and delete it.
- ◆ The user interface is as follows.

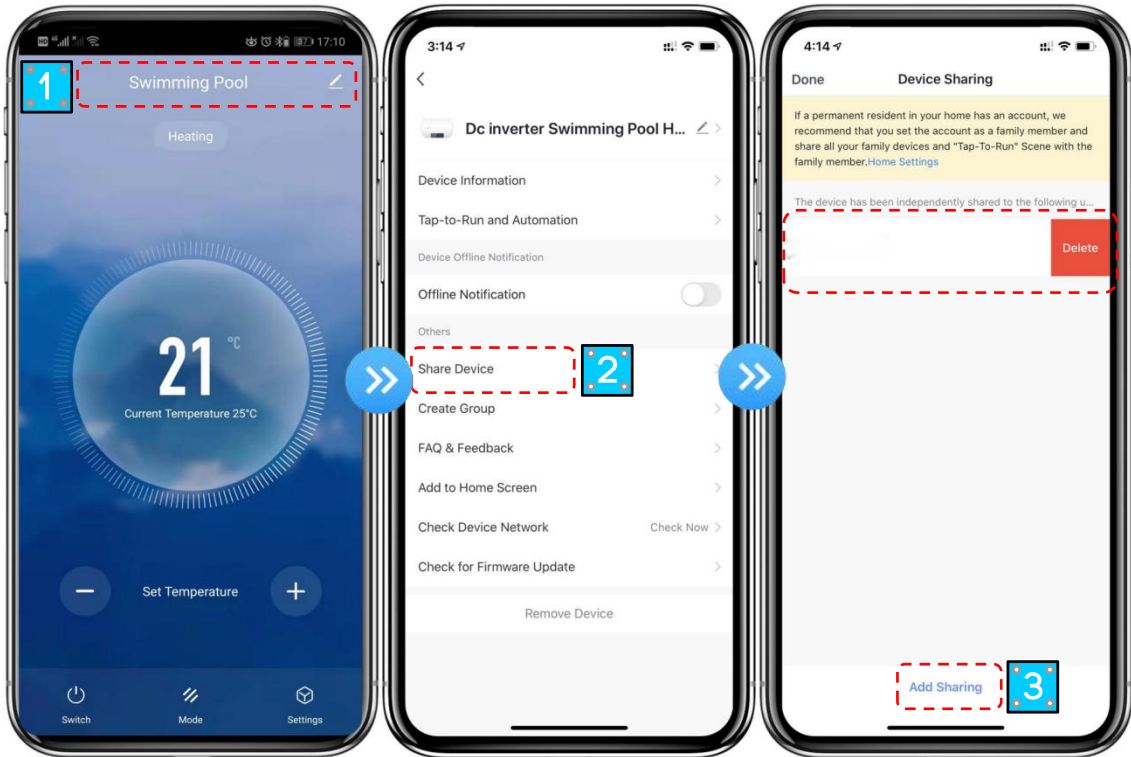

- ◆ Enter the account of the shared, click "Done", and the share success list shows the newly added account of the Shared.

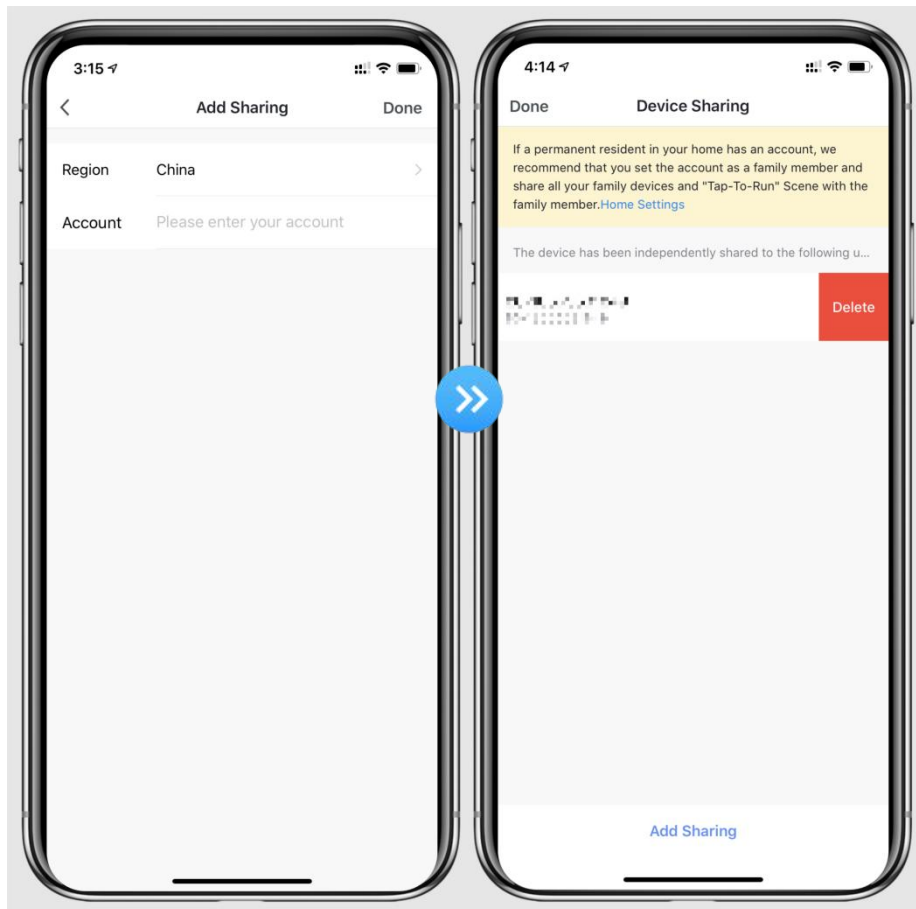

- ◆ The interface of the person to be shared is as follows. The received shared device is displayed.

Click it to operate and control the device.



● **Mode settings**

Click “” on the main interface to switch modes,select what you need.

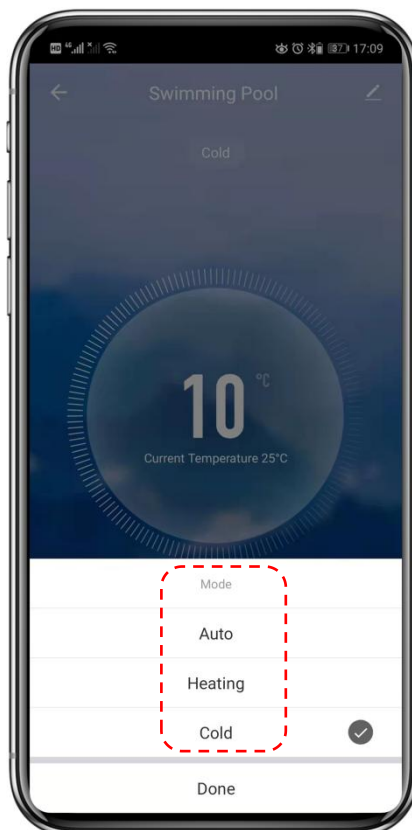

● **Timer setting**

1. Click “🕒” on the main interface to enter timer setting interface, as shown below, click to add timer.



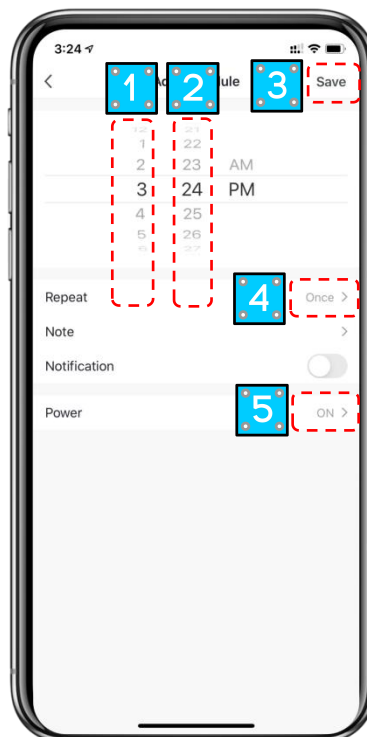

1. After entering timer setting, swipe up/down to set timer, set up repeat weeks and on/off, then click “save” to save your settings as follows.

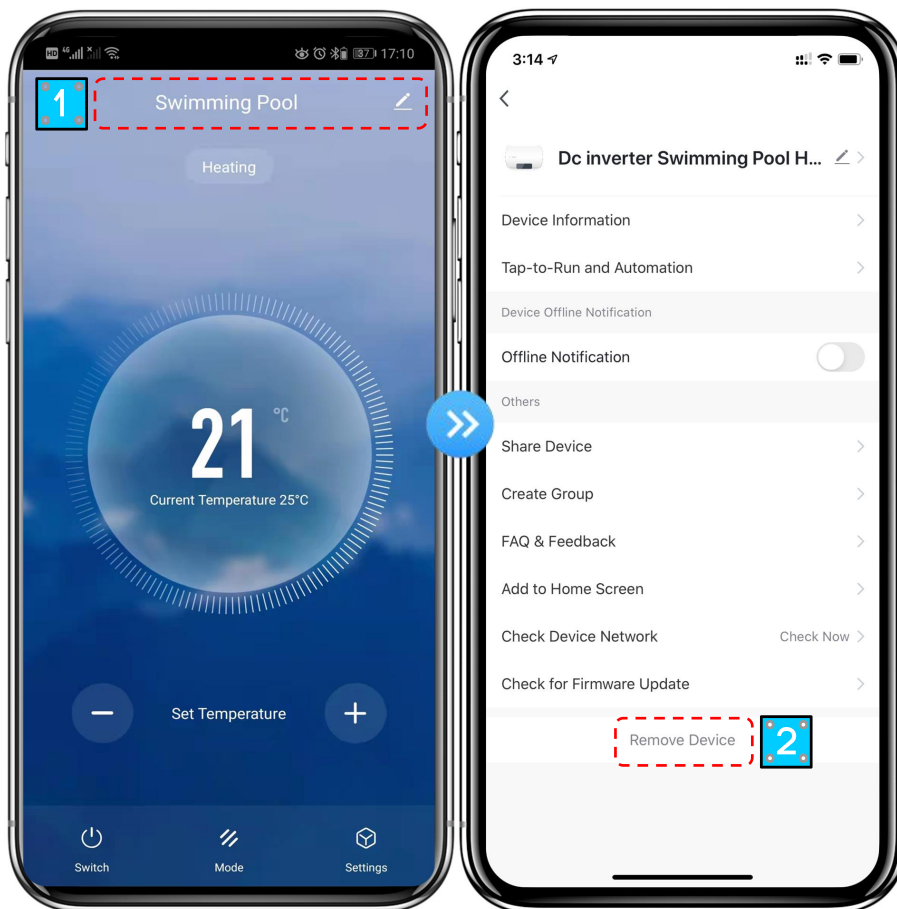

- ① Hours
- ② Minutes
- ③ Set the repetition
- ④ Set power ON/OFF
- ⑤ Save your modification

4.5.5 Device Removal

Click “

5. MAINTENANCE AND WINTERIZING

5.1 Maintenance

 **WARNING:** Before undertaking maintenance work on the unit, ensure that you have disconnected the electrical power supply.

- **Cleaning**

- a. The heat pump's casing must be cleaned with a damp cloth. The use of detergents or other household products could damage the surface of the casing and affect its properties.
- b. The evaporator at the rear of the heat pump must be carefully cleaned with a vacuum cleaner and soft brush attachment.

- **Annual maintenance**

The following operations must be undertaken by a qualified person at least once a year.

- a. Carry out safety checks.
- b. Check the integrity of the electrical wiring.
- c. Check the earthing connections.
- d. Monitor the state of the pressure gauge and the presence of refrigerant.

5.2 Winterizing



“CUT OFF” power supply of the heater before cleaning, examination and repairing

In winter season when you don't swim:

- a. Cut off power supply to prevent any machine damage.
- b. Drain water clear of the machine.

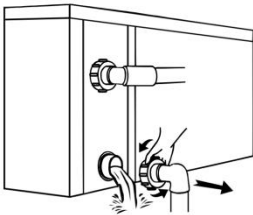

!! Important:

Unscrew the water nozzle of inlet pipe to let the water flow out. When the water in machine freezes in winter season, the titanium heat exchanger may be damaged.

- c. Cover the machine body when not in use.

116-06-10-00587